

**Preliminary** TOSHIBA CMOS Digital Integrated Circuit Silicon Monolithic

# TC90A66F

PAP/PIP/POP Controller for Wide-Screen TVs (PAL/NTSC)

With built-in AD and DA converters (ADC/DAC), the TC90A66F is a picture-and-picture (PAP)/picture-in-picture (PIP)/picture-out-picture (POP) controller IC for PAL and NTSC formats. It is used in combination with field memory, video signal processor ICs.

The TC90A66F enables a variety of picture display functions. The IC is optimal to provide wide-screen TVs with additional functionality.

## Features

- Two-channel 8-bit ADC, three-channel 8-bit DAC, clamp circuit, and multiplexer integrated on single chip
- External field memory  
Recommended memory: MSM51V8221, MSM51V8222 (By Oki)
- Picture display functions
  - PAP display Half-picture left and right sides of 16:9 screen (Motion Picture mode or Still mode selectable)
  - PIP display 4:3 or 16:9 aspect ratio (Motion Picture mode or Still mode selectable)
  - POP display 4:3 aspect ratio (3 pictures in Still mode, 1 picture in Motion Picture mode and 2 pictures in Still mode, or Strobe mode selectable)
  - Multi-picture still Display of up to 24 still pictures per screen
  - Channel search 9, 12, or 16 picture search (Still mode, Strobe mode, or 1 picture in Motion Picture mode selectable)
- Variable frame width and frame color
- Built-in horizontal and vertical filters
- I<sup>2</sup>C bus for micro controller interface
- 3.3-V single power supply
- Package: QFP144

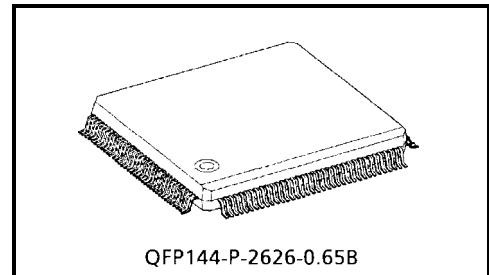

Weight: 4.64 g (typ.)

Pin Assignment

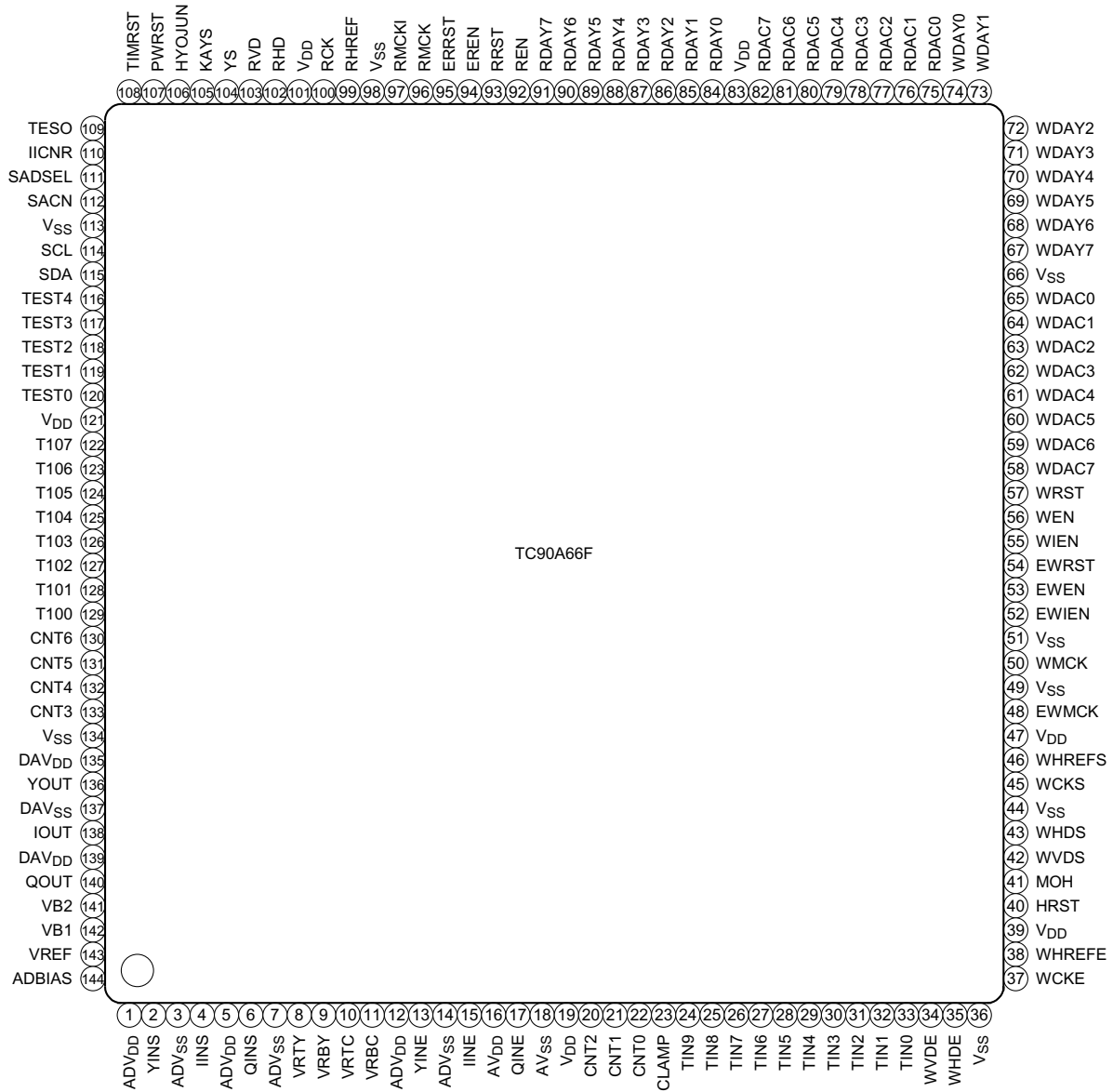

## System Block Diagram

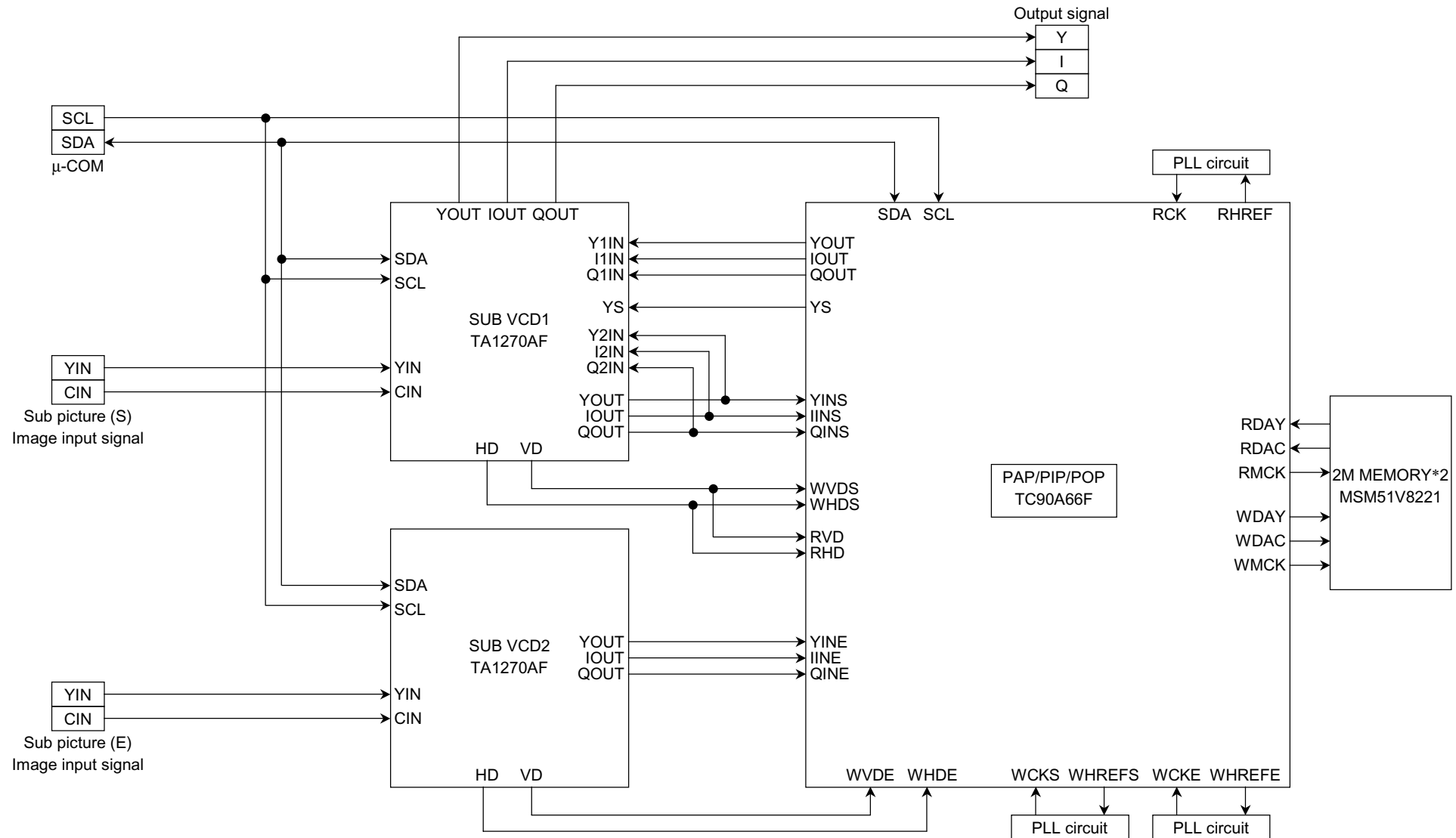

## TC90A66F Block Diagram

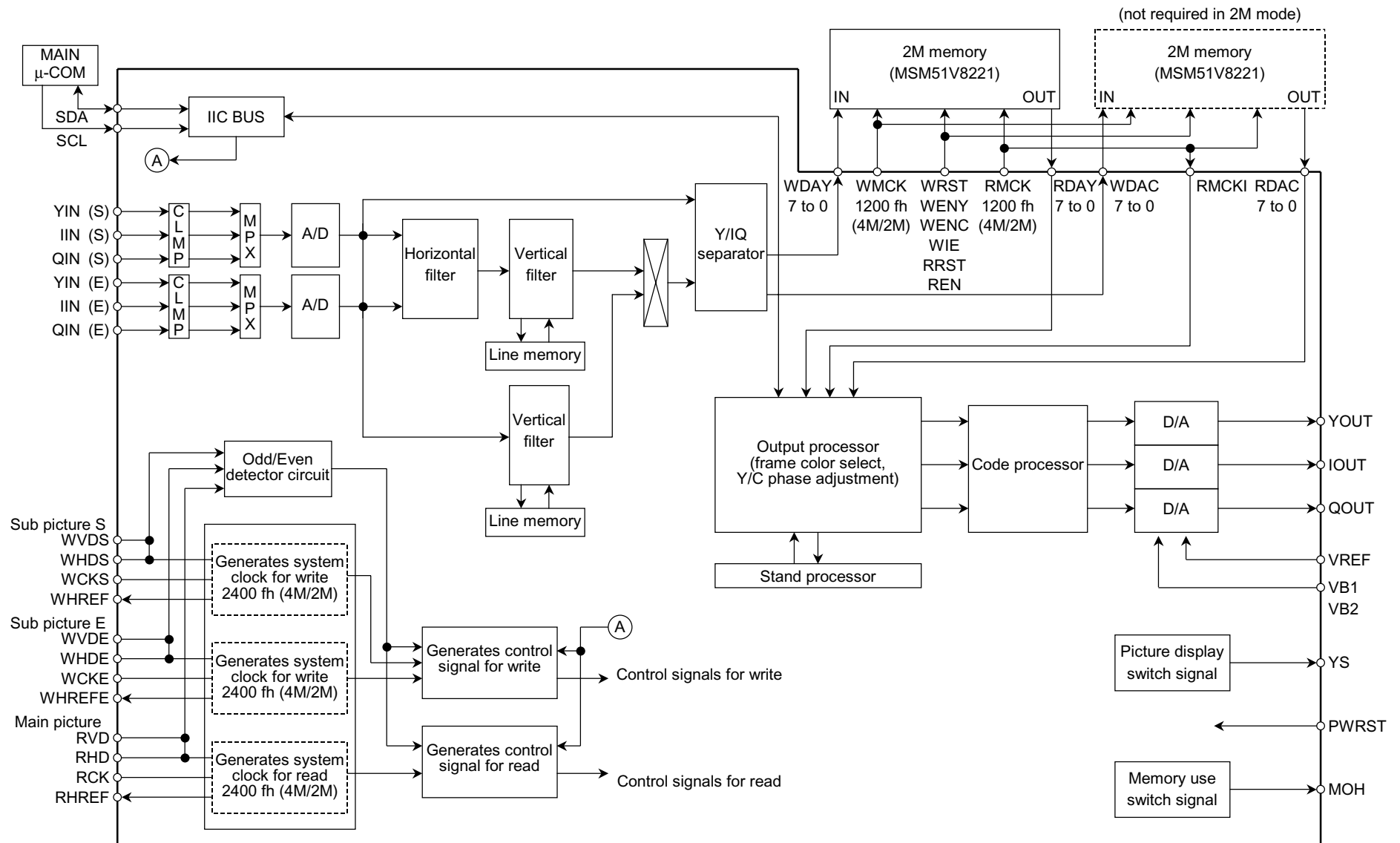

## Pin Functions (144-pin QFP)

Pin Number	Pin Name	I/O	Function
1	ADV <sub>DD</sub>	—	Power supply for A/D (3.3 V)
2	YINS	I	A/D Y signal (S system) input
3	ADV <sub>SS</sub>	—	GND for A/D
4	IINS	I	A/D I signal or R-Y signal (S system) input
5	ADV <sub>DD</sub>	—	Power supply for A/D (3.3 V)
6	QINS	I	A/D Q signal or B-Y signal (S system) input
7	ADV <sub>SS</sub>	—	GND for A/D
8	VRTY	I	Reference voltage for A/D Y signal (top)
9	VRBY	I	Reference voltage for A/D Y signal (bottom)
10	VRTC	I	Reference voltage for A/D I, Q signal (top)
11	VRBC	I	Reference voltage for A/D I, Q signal (bottom)
12	ADV <sub>DD</sub>	—	Power supply for A/D (3.3 V)
13	YINE	I	A/D Y signal (E system) input
14	ADV <sub>SS</sub>	—	GND for A/D
15	IINE	I	A/D I signal or R-Y signal (E system) input
16	AV <sub>DD</sub>	—	Power supply for analog circuit (3.3 V)
17	QINE	I	A/D Q signal or B-Y signal (E system) input
18	AV <sub>SS</sub>	—	GND for analog circuit
19	V <sub>DD</sub>	—	Power supply (3.3 V)
20	CNT2	O	Test output pin
21	CNT1	O	Test output pin
22	CNT0	O	Test output pin
23	CLAMP	O	Clamp signal monitor output
24	TIN9	I	Test input pin (connect to GND)
25	TIN8	I	Test input pin (connect to GND)
26	TIN7	I	Test input pin (connect to GND)
27	TIN6	I	Test input pin (connect to GND)
28	TIN5	I	Test input pin (connect to GND)
29	TIN4	I	Test input pin (connect to GND)
30	TIN3	I	Test input pin (connect to GND)
31	TIN2	I	Test input pin (connect to GND)
32	TIN1	I	Test input pin (connect to GND)
33	TIN0	I	Test input pin (connect to GND)
34	WVDE	I	(E system) vertical sync signal input (It can be inverted using I <sup>2</sup> C bus) (Note1)
35	WHDE	I	(E system) horizontal sync signal input (It can be inverted using I <sup>2</sup> C bus) (Note1)
36	V <sub>SS</sub>	—	GND
37	WCKE	I	(E system) system clock input (Note1)
38	WREFE	I/O	(E system) PLL phase comparison output
39	V <sub>DD</sub>	—	Power supply (3.3 V)
40	HRST	O	Unit adjusting pin
41	MOH	O	Memory use switch signal [(YCS (L)·TC90A66F (H))]

Note1: Supports 5 V interface.

Pin Number	Pin Name	I/O	Function
42	WVDS	I	(S system) vertical sync signal input (It can be inverted using I <sup>2</sup> C bus) (Note1)
43	WHDS	I	(S system) horizontal sync signal input (It can be inverted using I <sup>2</sup> C bus) (Note1)
44	V <sub>SS</sub>	—	GND
45	WCKS	I	(S system) system clock input (Note1)
46	WHREFS	O	(S system) PLL phase comparison output
47	V <sub>DD</sub>	—	Power supply (3.3 V)
48	EWMCK	O	(E system) write clock output for field memory
49	V <sub>SS</sub>	—	GND
50	WMCK	O	(S system) write clock output for field memory
51	V <sub>SS</sub>	—	GND
52	EWIEN	O	(E system) field memory input enable
53	EWEN	O	(E system) field memory write enable
54	EWRST	O	(E system) field memory write reset
55	WIEN	O	(S system) field memory input enable
56	WEN	O	(S system) field memory write enable
57	WRST	O	(S system) field memory write reset
58	WDAC7	O	IQ or sub picture (E system) signal output (field memory write signal/MSB)
59	WDAC6	O	IQ or sub picture (E system) signal output (field memory write signal/ : )
60	WDAC5	O	IQ or sub picture (E system) signal output (field memory write signal/ : )
61	WDAC4	O	IQ or sub picture (E system) signal output (field memory write signal/ : )
62	WDAC3	O	IQ or sub picture (E system) signal output (field memory write signal/ : )
63	WDAC2	O	IQ or sub picture (E system) signal output (field memory write signal/ : )
64	WDAC1	O	IQ or sub picture (E system) signal output (field memory write signal/ : )
65	WDAC0	O	IQ or sub picture (E system) signal output (field memory write signal/LSB)
66	V <sub>SS</sub>	—	GND
67	WDAY7	O	Y or sub picture (S system) signal output (field memory write signal/MSB)
68	WDAY6	O	Y or sub picture (S system) signal output (field memory write signal/ : )
69	WDAY5	O	Y or sub picture (S system) signal output (field memory write signal/ : )
70	WDAY4	O	Y or sub picture (S system) signal output (field memory write signal/ : )
71	WDAY3	O	Y or sub picture (S system) signal output (field memory write signal/ : )
72	WDAY2	O	Y or sub picture (S system) signal output (field memory write signal/ : )
73	WDAY1	O	Y or sub picture (S system) signal output (field memory write signal/ : )
74	WDAY0	O	Y or sub picture (S system) signal output (field memory write signal/LSB)
75	RDAC0	I	IQ or sub picture (E system) signal input (field memory read signal/LSB) (Note1)
76	RDAC1	I	IQ or sub picture (E system) signal input (field memory read signal/ : ) (Note1)
77	RDAC2	I	IQ or sub picture (E system) signal input (field memory read signal/ : ) (Note1)
78	RDAC3	I	IQ or sub picture (E system) signal input (field memory read signal/ : ) (Note1)
79	RDAC4	I	IQ or sub picture (E system) signal input (field memory read signal/ : ) (Note1)
80	RDAC5	I	IQ or sub picture (E system) signal input (field memory read signal/ : ) (Note1)
81	RDAC6	I	IQ or sub picture (E system) signal input (field memory read signal/ : ) (Note1)
82	RDAC7	I	IQ or sub picture (E system) signal input (field memory read signal/MSB) (Note1)
83	V <sub>DD</sub>	—	Power supply (3.3 V)
84	RDAY0	I	Y or sub picture (S system) signal input (field memory read signal/LSB) (Note1)

Note1: Supports 5 V interface.

Pin Number	Pin Name	I/O	Function
85	RDAY1	I	Y or sub picture (S system) signal input (field memory read signal/ : ) (Note1)
86	RDAY2	I	Y or sub picture (S system) signal input (field memory read signal/ : ) (Note1)
87	RDAY3	I	Y or sub picture (S system) signal input (field memory read signal/ : ) (Note1)
88	RDAY4	I	Y or sub picture (S system) signal input (field memory read signal/ : ) (Note1)
89	RDAY5	I	Y or sub picture (S system) signal input (field memory read signal/ : ) (Note1)
90	RDAY6	I	Y or sub picture (S system) signal input (field memory read signal/ : ) (Note1)
91	RDAY7	I	Y or sub picture (S system) signal input (field memory read signal/MSB) (Note1)
92	REN	O	(S system) field memory read enable
93	RRST	O	(S system) field memory read reset
94	EREN	O	(E system) field memory read enable
95	ERRST	O	(E system) field memory read reset
96	RMCK	O	(S/E system) read clock output for field memory
97	RMCKI	I	RMCK input (phase adjustment)
98	V <sub>SS</sub>	—	GND
99	RHREF	O	PLL phase comparison output for main picture
100	RCK	I	System clock input for main picture (Note1)
101	V <sub>DD</sub>	—	Power supply (3.3 V)
102	RHD	I	Horizontal sync single input for main picture (It can be inverted using I <sup>2</sup> C bus) (Note1)
103	RVD	I	Vertical sync single input for main picture (It can be inverted using I <sup>2</sup> C bus) (Note1)
104	YS	O	YS signal output
105	KAYS	O	Wallpaper YS signal output
106	HYOJUN	O	Standard/non-standard signal output [standard (L)/non-standard (H)]
107	PWRST	I	System reset input [reset (L)]
108	TIMRST	I	Test reset input [reset (H)/normal (L)]
109	TESO	O	Test monitor output
110	IICNR	I	I <sup>2</sup> C bus noise reduction circuit [on (H)/off (L)]
111	SADSEL	I	Main/sub sub address switch [main (H)/sub (L)]
112	SACN	O	I <sup>2</sup> C bus acknowledge output pin
113	V <sub>SS</sub>	—	GND
114	SCL	I	I <sup>2</sup> C bus serial clock input (Note1)
115	SDA	I/O	I <sup>2</sup> C bus serial data input (IN)/acknowledge (OUT) (Note1)
116	TEST4	I	Test input pin (connect to GND)
117	TEST3	I	Test input pin (connect to GND)
118	TEST2	I	Test input pin (connect to GND)
119	TEST1	I	Test input pin (connect to GND)
120	TEST0	I	Test input pin (connect to GND)
121	V <sub>DD</sub>	—	Power supply (3.3 V)
122	TIO7	I/O	Test input/output pin (normally, open)
123	TIO6	I/O	Test input/output pin (normally, open)
124	TIO5	I/O	Test input/output pin (normally, open)
125	TIO4	I/O	Test input/output pin (normally, open)
126	TIO3	I/O	Test input/output pin (normally, open)
127	TIO2	I/O	Test input/output pin (normally, open)

Note1: Supports 5 V interface.

Pin Number	Pin Name	I/O	Function
128	TIO1	I/O	Test input/output pin (normally, open)
129	TIO0	I/O	Test input/output pin (normally, open)
130	CNT6	O	Test output pin
131	CNT5	O	Test output pin
132	CNT4	O	Test output pin
133	CNT3	O	Test output pin
134	V <sub>SS</sub>	—	GND
135	DAV <sub>DD</sub>	—	Power supply for D/A (3.3 V)
136	YOUT	O	Y Signal output
137	DAV <sub>SS</sub>	—	D/A GND
138	IOUT	O	I signal or R-Y signal output
139	DAV <sub>DD</sub>	—	Power supply for D/A (3.3 V)
140	QOUT	O	Q signal or B-Y signal output
141	VB2	—	D/A bias
142	VB1	—	D/A bias
143	VREF	I	D/A reference bias (supply 2.3 V)
144	ADBIAS	—	A/D bias



## Pin Description

Pin Number	Pin Name	Function
2	YINS	Y-signal (S system) analog input Input amplitude is 1 V <sub>p-p</sub> typical.
4	IINS	I or R-Y signal (S system) analog input Input amplitude is 1 V <sub>p-p</sub> typical.
6	QINS	Q or B-Y signal (S system) analog input Input amplitude is 1 V <sub>p-p</sub> typical.
8	VRTY	High-level reference power supply pin for ADC Y signal. Sets the upper limit of the ADC dynamic range. Fixed to 2.2 V (typ.) by internal resistance type potential division. Connect 0.1 μF bypass capacitor between the pin and GND.
9	VRBY	Low-level reference power supply voltage for ADC Y signal. Sets the lower limit of the ADC dynamic range. Fixed to 1.1 V (typ.) by internal resistance type potential division. Connect 0.1 μF bypass capacitor between the pin and GND.
10	VRTC	High-level reference power supply pin for ADC IQ signal. Sets the upper limit of the ADC dynamic range. Fixed to 2.2 V (typ.) by internal resistance type potential division. Connect 0.1 μF bypass capacitor between the pin and GND.
11	VRBC	Low-level reference power supply voltage for ADC IQ signal. Sets the lower limit of the ADC dynamic range. Fixed to 1.1 V (typ.) by internal resistance type potential division. Connect 0.1 μF bypass capacitor between the pin and GND.
13	YINE	Y signal (E system) analog input Input amplitude is 1 V <sub>p-p</sub> typical.
15	IINE	I or R-Y signal (E system) analog input Input amplitude is 1 V <sub>p-p</sub> typical.
17	QINE	Q or B-Y signal (E system) analog input Input amplitude is 1 V <sub>p-p</sub> typical.
23	CLAMP	Clamp signal monitor output pin. Can monitor clamp pulse start/stop position set at 24h or 25h. Outputs signal for the last data (S or E system) transfer.
34	WVDE	(E system) vertical sync signal input pin. (It can be inverted using I <sup>2</sup> C bus) Inputs vertical sync signal from VCD for sub picture E. It is composing 5 V interface. For negative polarity input, set sub address [26H: EVINV] to L (negative polarity input).
35	WHDE	(E system) horizontal sync signal input pin. (It can be inverted using I <sup>2</sup> C bus) Inputs horizontal sync signal from VCD for sub picture E. It is composing 5 V interface. For negative polarity input, set sub address [26H: EHINV] to L (negative polarity input).
37	WCKE	(E system) write clock input pin. Inputs from the external PLL circuit. It is composing 5 V interface. Inputs 2400 fH for both 4M and 2M memory mode.
38	WHREFE	(E system) PLL phase comparison output. The HREF signal obtained by the I/N divider circuit or the phase comparison result of sub picture (E) horizontal sync signal.
40	HRST	Unit adjustment (WS/WE/R switch able)
41	MOH	External field memory use signal output pin. Output amplitude is 3.3 V <sub>p-p</sub> typical. Setting sub address [21H: MOH] to H uses TC90A66F; setting to L sets all memory output pins to Hi-Z.
42	WVDS	(S system) vertical sync signal input pin. (It can be inverted using I <sup>2</sup> C bus) Inputs vertical sync signal from VCD for sub picture S. It is composing 5 V interface. For negative polarity input, set sub address [27H: WVINV] to L (negative polarity input).
43	WHDS	(S system) horizontal sync signal input pin. (It can be inverted using I <sup>2</sup> C bus) Inputs horizontal sync signal from VCD for sub picture S. It is composing 5 V interface. For negative polarity input, set sub address [27H: WHINV] to L (negative polarity input).
45	WCKS	(S system) write clock input pin. Inputs from the external PLL circuit. It is composing 5 V interface. Inputs 2400 fH for both 4M and 2M memory mode.

Pin Number	Pin Name	Function
46	WHREFS	(S system) PLL phase comparison output. The HREF signal obtained by the I/N divider circuit or the phase comparison result of sub picture (S) horizontal sync signal. This signal is used to control the external VCO voltage.
48	EWMCK	Outputs sub picture E write clock to external field memory. Output amplitude is 3.3 V <sub>p-p</sub> typical.
50	WMCK	Outputs sub picture S write clock to external field memory. Output amplitude is 3.3 V <sub>p-p</sub> typical.
52	EWIEN	Control signal output pin for external field memory (sub picture E). Output amplitude is 3.3 V <sub>p-p</sub> typical.
53	EWEN	Control signal output pin for external field memory (sub picture E). Output amplitude is 3.3 V <sub>p-p</sub> typical.
54	EWRST	Control signal output pin for external field memory (sub picture E). Output amplitude is 3.3 V <sub>p-p</sub> typical.
55	WIEN	Control signal output pin for external field memory (sub picture S). Output amplitude is 3.3 V <sub>p-p</sub> typical.
56	WEN	Control signal output pin for external field memory (sub picture S). Output amplitude is 3.3 V <sub>p-p</sub> typical.
57	WRST	Control signal output pin for external field memory (sub picture S). Output amplitude is 3.3 V <sub>p-p</sub> typical.
58 to 65	WDAC7-0	Output signal to write to external field memory. (I, Q or E system). Output amplitude is 3.3 V <sub>p-p</sub> typical. Connect only when using 4M memory. MSB: WDAC7, LSB: WDAC0
67 to 75	WDAY7-0	Output signal to write to external field memory. (Y or S system). Output amplitude is 3.3 V <sub>p-p</sub> typical. MSB: WDAY7, LSB: WDAY0
75 to 82	RDAC0-7	Input signal to read from external field memory (I, Q or E system). It is composing 5 V interface. Connect only when using 4M memory. MSB: RDAC7, LSB: RDAC0
84 to 91	RDAY0-7	Input signal to read from external field memory (Y or S system). It is composing 5 V interface. MSB: RDAY7, LSB: RDAY0
92	REN	Control signal output pin for external field memory (sub picture S). Output amplitude is 3.3 V <sub>p-p</sub> typical.
93	RRST	Control signal output pin for external field memory (sub picture S). Output amplitude is 3.3 V <sub>p-p</sub> typical.
94	EREN	Control signal output pin for external field memory (sub picture E). Output amplitude is 3.3 V <sub>p-p</sub> typical.
95	ERRST	Control signal output pin for external field memory (sub picture E). Output amplitude is 3.3 V <sub>p-p</sub> typical.
96	RMCK	Outputs read clock to external field memory. Output amplitude is 3.3 V <sub>p-p</sub> typical. Outputs 1200 fH for both 4M and 2M memory.
97	RMCKI	RMCK phase adjustment input pin. Inputs RMCK.

Pin Number	Pin Name	Function
99	RHREF	PLL phase compare output pin for main picture. The HREF signal obtained by the I/N divider circuit or the phase comparison result of RHD signal. This signal is used to control the external VCO voltage.
100	RCK	Read clock input pin. It is composing 5 V interface. Inputs from the external PLL circuit. Inputs 2400 fH for both 4M and 2M memory.
102	RHD	Horizontal sync signal input pin for main picture (read). Inputs horizontal sync signal from VCD for main picture. It is composing 5 V interface (negative polarity input). For negative polarity input, set sub address [28H: RHINV] to non-inversion (L).
103	RVD	Vertical sync signal input pin for main picture (read). Inputs vertical sync signal from VCD for main picture. It is composing 5 V interface (negative polarity input). For negative polarity input, set sub address [28H: RVINV] to non-inversion (L).
104	YS	Main/sub picture switch timing signal output pin. Output amplitude is 3.3 V <sub>p-p</sub> typical. When the YS signal is High, displays sub picture.
105	KAYS	Wallpaper YS signal output.
106	HYOJUN	Standard/non-standard signal output pin [standard (L)/non-standard (H)]
107	PWRST	System reset input pin. When low input, it carries out the reset. At least 1 V is required as reset duration.
110	IICNR	I <sup>2</sup> C bus noise reduction circuit setting pin. When set to on (connect to V <sub>DD</sub> ), data are latched once by the internal clock, then written to register. When set to off (connect to GND), data are written to register directly.
111	SADSEL	Sub address of main/sub picture switching pin. [main (H)/sub (L)] Normally, set to L (enables sub addresses 00h to 7Fh).
112	SACN	I <sup>2</sup> C bus acknowledge output pin.
114	SCL	I <sup>2</sup> C bus serial clock input pin. It is composing 5 V interface.
115	SDA	I <sup>2</sup> C bus serial data input/acknowledge output pin. It is composing 5 V interface.
136	YOUT	Y signal output pin. Output amplitude is 0.9 V <sub>p-p</sub> typical.
138	IOUT	I signal output pin. Output amplitude is 0.9 V <sub>p-p</sub> typical.
140	QOUT	Q signal output pin. Output amplitude is 0.9 V <sub>p-p</sub> typical.
141 to 142	VB2-1	Bias pin for DAC. Connect a 0.1 μF bypass capacitor between the pins and GND.
143	VREF	DAC reference voltage input pin. Reference voltage is 2.3 V typical.
144	ADBIAS	Bias pin for ADC. Connect a 0.1 μF bypass capacitor between the pin and AGND.

**Example of Typical A/D Converter Input Level for Luminance Signal**

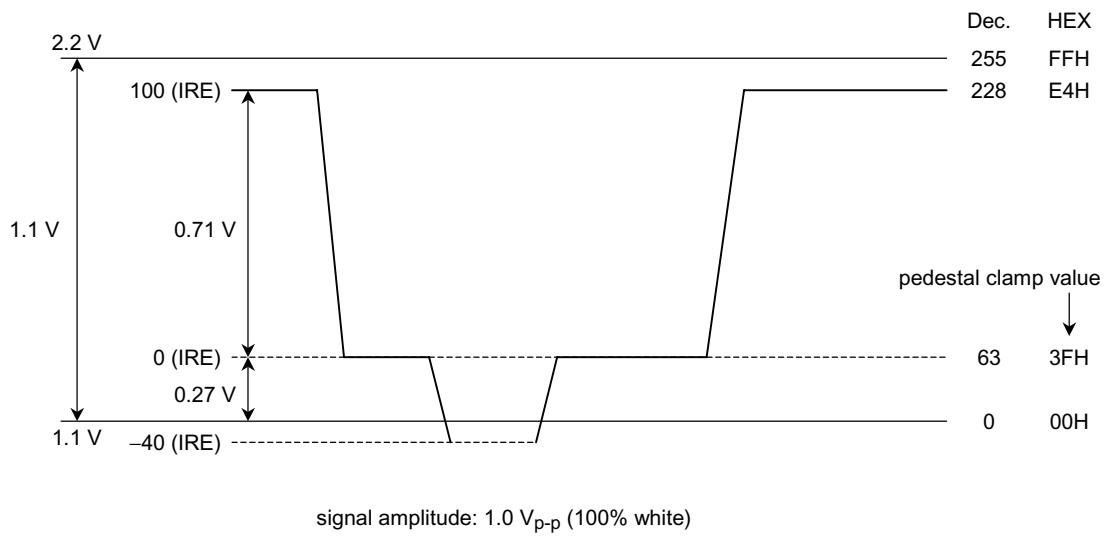

**Example of Typical A/D Converter Input Level for Chrominance Signal**

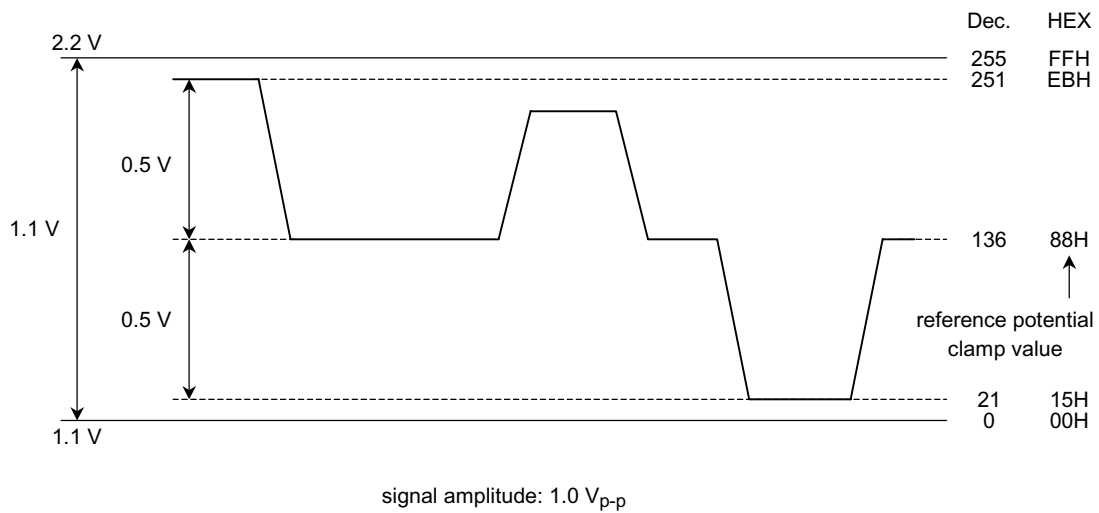

**Example of Typical D/A Converter Output Level for Luminance Signal**

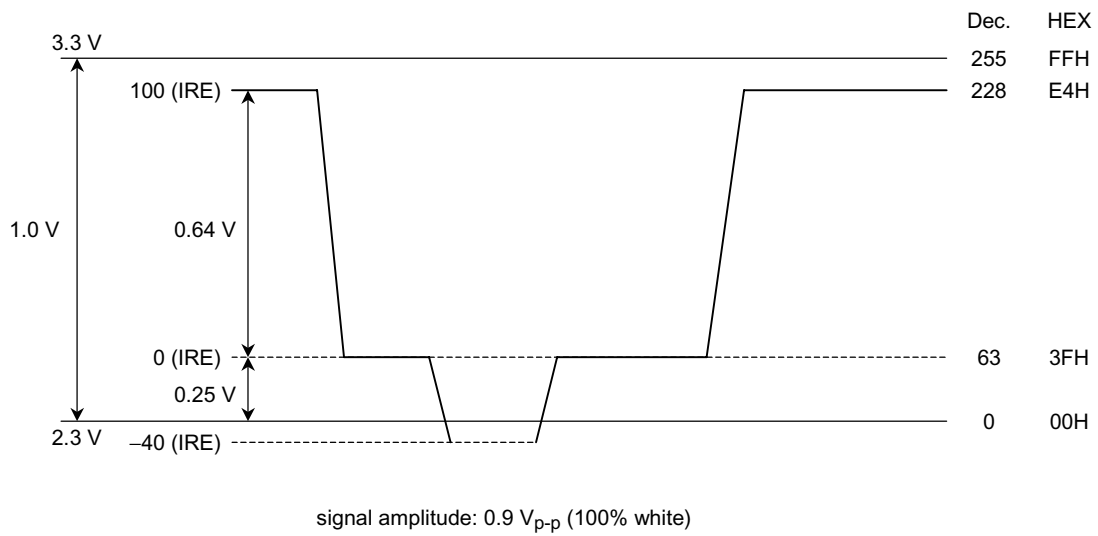

**Example of Typical D/A Converter Output Level for Chrominance Signal**

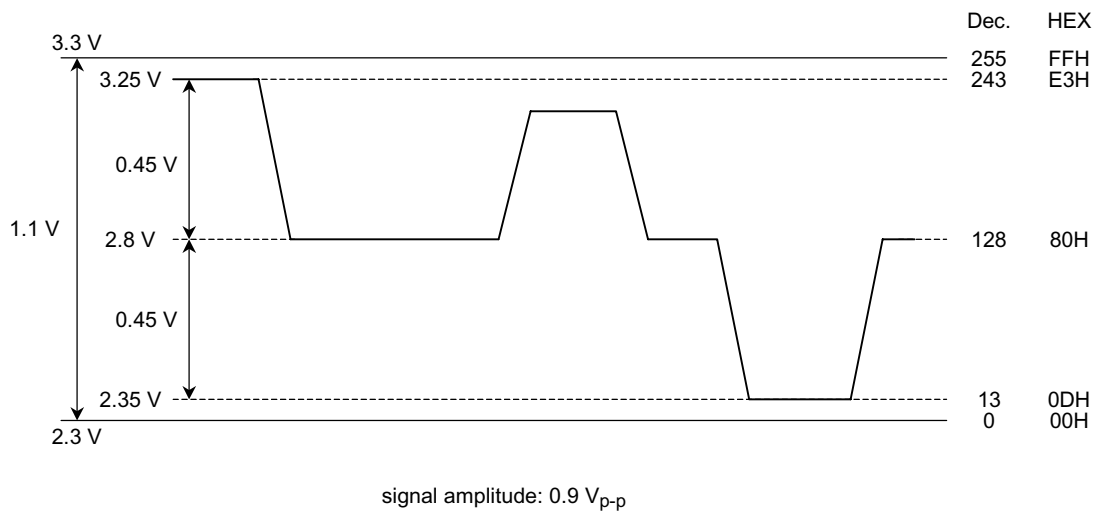

**Picture Display Function**

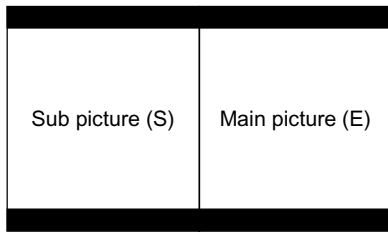

2-picture (PAP) display  
 4:3 aspect ratio (full picture can be displayed)  
 sub picture (S), (E): motion or still  
 (pictures can be exchanged)

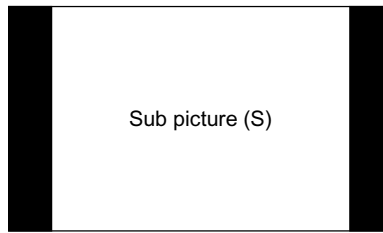

1-picture display  
 (full picture can be used)

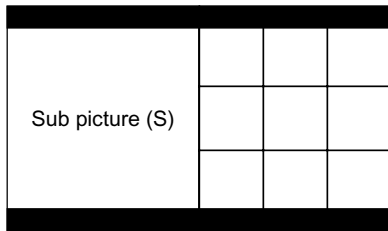

Multi search pictures  
 Sub picture (S): motion or still  
 Sub picture (E): 9 or 12 still pictures, strobe display or  
 only 1 motion picture and others still.

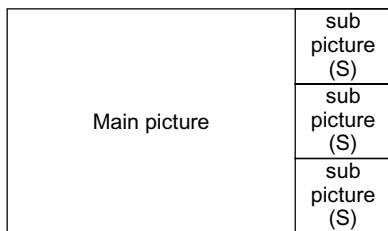

3-picture POP display  
 Sub picture: 4:3 aspect ratio Still, strobe, only 1  
 motion picture  
 Main picture: display using TC90A18AF (EDWAC)

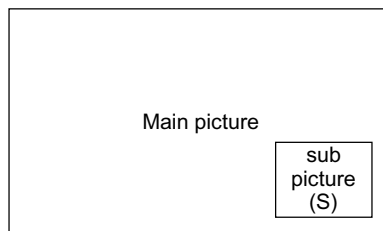

PIP display  
 Sub picture: 16:9 or 4:3 aspect ratio  
 Motion or still  
 Main picture: display using TC90A18AF (EDWAC)

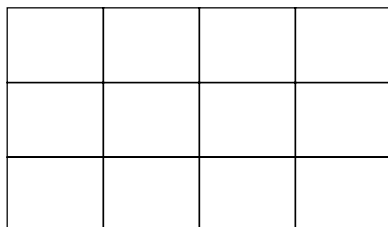

Multiple picture search using the whole screen  
 12 or 9 still pictures, strobe display,  
 only 1 motion picture and others still

## I<sup>2</sup>C Bus Address Setting Table

Sub Address		MSB															LSB
Hex	Dec	15	14	13	12	11	10	9	8	7	6	5	4	3	2	1	0
00	0	MYPH2	→ 1	→ 0	MYQPH0	RRSTINV	RCKINV	RREPH1	→ 0	M4M2	SESW						
01	1			YSBACT	FRACLR	YSCCLR	YSBCLR	YSACLR									
02	2	MBLKIQ7	→ 6	→ 5	→ 4	→ 3	→ 2	→ 1	→ 0	MBLKY7	→ 6	→ 5	→ 4	→ 3	→ 2	→ 1	→ 0
03	3	MMWIQ7	→ 6	→ 5	→ 4	→ 3	→ 2	→ 1	→ 0	MMWY7	→ 6	→ 5	→ 4	→ 3	→ 2	→ 1	→ 0
04	4																
05	5																
06	6																
07	7																
08	8																
09	9					RHYSAE11	→ 10	→ 9	→ 8	→ 7	→ 6	→ 5	→ 4	→ 3	→ 2	→ 1	→ 0
0A	10					RHYAS11	→ 10	→ 9	→ 8	→ 7	→ 6	→ 5	→ 4	→ 3	→ 2	→ 1	→ 0
0B	11							RVYSAE9	→ 8	→ 7	→ 6	→ 5	→ 4	→ 3	→ 2	→ 1	→ 0
0C	12							RVYSAS9	→ 8	→ 7	→ 6	→ 5	→ 4	→ 3	→ 2	→ 1	→ 0
0D	13					RHYBE11	→ 10	→ 9	→ 8	→ 7	→ 6	→ 5	→ 4	→ 3	→ 2	→ 1	→ 0
0E	14					RHYBS11	→ 10	→ 9	→ 8	→ 7	→ 6	→ 5	→ 4	→ 3	→ 2	→ 1	→ 0
0F	15							RVYSBE9	→ 8	→ 7	→ 6	→ 5	→ 4	→ 3	→ 2	→ 1	→ 0
10	16							RVYSBS9	→ 8	→ 7	→ 6	→ 5	→ 4	→ 3	→ 2	→ 1	→ 0
11	17					RHYSC11	→ 10	→ 9	→ 8	→ 7	→ 6	→ 5	→ 4	→ 3	→ 2	→ 1	→ 0
12	18					RHYSCS11	→ 10	→ 9	→ 8	→ 7	→ 6	→ 5	→ 4	→ 3	→ 2	→ 1	→ 0
13	19							RVYSCE9	→ 8	→ 7	→ 6	→ 5	→ 4	→ 3	→ 2	→ 1	→ 0
14	20							RVYSCS9	→ 8	→ 7	→ 6	→ 5	→ 4	→ 3	→ 2	→ 1	→ 0
15	21					RHSIZ11	→ 10	→ 9	→ 8	→ 7	→ 6	→ 5	→ 4	→ 3	→ 2	→ 1	→ 0
16	22							RVSIZ9	→ 8	→ 7	→ 6	→ 5	→ 4	→ 3	→ 2	→ 1	→ 0
17	23		ROEFON	RGAME	DWSW	RRH11	→ 10	→ 9	→ 8	→ 7	→ 6	→ 5	→ 4	→ 3	→ 2	→ 1	→ 0
18	24	FRFI	ROEALT	RFISW	RFALT			RRV9	→ 8	→ 7	→ 6	→ 5	→ 4	→ 3	→ 2	→ 1	→ 0

Note2: Set 0 in blank columns.

Sub Address		MSB															LSB
Hex	Dec	15	14	13	12	11	10	9	8	7	6	5	4	3	2	1	0
19	25							RWRN9	→ 8	→ 7	→ 6	→ 5	→ 4	→ 3	→ 2	→ 1	→ 0
1A	26							RWRA9	→ 8	→ 7	→ 6	→ 5	→ 4	→ 3	→ 2	→ 1	→ 0
1B	27	RHRFTH	RHRFIV	RHINV2	RCKCHG	PRHP11	→ 10	→ 9	→ 8	→ 7	→ 6	→ 5	→ 4	→ 3	→ 2	→ 1	→ 0
1C	28					RPLLPH11	→ 10	→ 9	→ 8	→ 7	→ 6	→ 5	→ 4	→ 3	→ 2	→ 1	→ 0
1D	29	DWFIL	JSWAP				WHST10	→ 9	→ 8	→ 7	→ 6	→ 5	→ 4	→ 3	→ 2	→ 1	→ 0
1E	30	WHMOD3	→ 2	→ 1	→ 0	WCKINV	WHED10	→ 9	→ 8	→ 7	→ 6	→ 5	→ 4	→ 3	→ 2	→ 1	→ 0
1F	31	WEYINV		WEYDL2	→ 1	IENINV	KWST10	→ 9	→ 8	→ 7	→ 6	→ 5	→ 4	→ 3	→ 2	→ 1	→ 0
20	32	WECINV	WECDL2	→ 1	→ 0	WEPCM	KWED10	→ 9	→ 8	→ 7	→ 6	→ 5	→ 4	→ 3	→ 2	→ 1	→ 0
21	33	WHRFTH	WHRFIV	WHINV2	MOH	SHRST11	→ 10	→ 9	→ 8	→ 7	→ 6	→ 5	→ 4	→ 3	→ 2	→ 1	→ 0
22	34	PCMAIN	SIQINV	EIQINV		EHRST11	→ 10	→ 9	→ 8	→ 7	→ 6	→ 5	→ 4	→ 3	→ 2	→ 1	→ 0
23	35				WCKEON	PHREF11	→ 10	→ 9	→ 8	→ 7	→ 6	→ 5	→ 4	→ 3	→ 2	→ 1	→ 0
24	36	SCLPST7	→ 6	→ 5	→ 4	→ 3	→ 2	→ 1	→ 0	SCLPED7	→ 6	→ 5	→ 4	→ 3	→ 2	→ 1	→ 0
25	37	ECLPST7	→ 6	→ 5	→ 4	→ 3	→ 2	→ 1	→ 0	ECLPED7	→ 6	→ 5	→ 4	→ 3	→ 2	→ 1	→ 0
26	38	WPLHS	EPLHS	EHINV	EVINV	NTPAL				RPLHS	HDWDT7	→ 6	→ 5	→ 4	→ 3	→ 2	→ 1
27	39	WHIHYO	WKHYO	WHINV	WVINV	WS262	HYJ3	→ 2	→ 1	WVMSK7	→ 6	→ 5	→ 4	→ 3	WOERSTN	EHIHYO	EKHYO
28	40	RHIHYO	RKHYO	RHINV	RVINV	RS262	HIJ3	→ 2	→ 1	RVMSK7	→ 6	→ 5	→ 4	→ 3	→ 2	→ 1	→ 0
29	41	JVLOCHG	JFMINT	JVLOINV	WKYFRM	MAINRST	MSKOFF	VFILOFF	WVST8	→ 7	→ 6	→ 5	→ 4	→ 3	→ 2	→ 1	→ 0
2A	42	JWRTON	POEINV	INT3S2				RSTDEL	WVED8	→ 7	→ 6	→ 5	→ 4	→ 3	→ 2	→ 1	→ 0
2B	43	FIELD	VSPD1	→ 0	JVSCRL				VL8	→ 7	→ 6	→ 5	→ 4	→ 3	→ 2	→ 1	→ 0
2C	44	MWBACK	BVIE5	→ 4	→ 3	→ 2	→ 1	→ 0	BVWE8	→ 7	→ 6	→ 5	→ 4	→ 3	→ 2	→ 1	→ 0
2D	45	MULT	STREND	VSKOFF	KSKOFF		RANDM	HIE9	→ 8	→ 7	→ 6	→ 5	→ 4	→ 3	→ 2	→ 1	→ 0
2E	46	BHIE5	→ 4	→ 3	→ 2	→ 1	→ 0	KJH9	→ 8	→ 7	→ 6	→ 5	→ 4	→ 3	→ 2	→ 1	→ 0
2F	47	BVRN3	→ 2	→ 1	→ 0	BHRN3	→ 2	→ 1	→ 0	KJV7	→ 6	→ 5	→ 4	→ 3	→ 2	→ 1	→ 0
30	48	ATMV3	→ 2	→ 1	→ 0	ATMH3	→ 2	→ 1	→ 0	ATFLD7	→ 6	→ 5	→ 4	→ 3	→ 2	→ 1	→ 0
31	49	STMV3	→ 2	→ 1	→ 0	STMH3	→ 2	→ 1	→ 0	STVS7	→ 6	→ 5	→ 4	→ 3	→ 2	→ 1	→ 0
32	50			ATSTRV	ATSTRH	AT2CHG		STHS9	→ 8	→ 7	→ 6	→ 5	→ 4	→ 3	→ 2	→ 1	→ 0

Note2: Set 0 in blank columns.



Sub Address		MSB															LSB
Hex	Dec	15	14	13	12	11	10	9	8	7	6	5	4	3	2	1	0
33	51	CHMV3	→ 2	→ 1	→ 0	CHMH3	→ 2	→ 1	→ 0	ATLV3	→ 2	→ 1	→ 0	ATLH3	→ 2	→ 1	→ 0
34	52							RH9	→ 8	→ 7	→ 6	→ 5	→ 4	→ 3	→ 2	→ 1	→ 0
35	53	YCMF2	YCMF1	YCMN	C2HFT	Y2HFT	W1NSEL	THRUY	KMODE	THRUYC	YDL2	→ 1	→ 0	KTC	KTB	KTA	OFSET
36	54	KD15	→ 14	→ 13	→ 12	→ 11	→ 10	→ 9	→ 8	→ 7	→ 6	→ 5	→ 4	→ 3	→ 2	→ 1	→ 0
37	55	KD31	→ 30	→ 29	→ 28	→ 27	→ 26	→ 25	→ 24	→ 23	→ 22	→ 21	→ 20	→ 19	→ 18	→ 17	→ 16
38	56									HFSPAIV				YLPFCH	THRUC	CLPFTH	YLPFTH
39	57					VFN3	→ 2	→ 1	→ 0			VFYTH	VKOS4	→ 3	→ 2	→ 1	→ 0
3A	58																
3B	59					SYCINV	PCMAIN		STHRU								
3C	60																
3D	61																
3E	62																
3F	63																
40	64										FRAON	BMASKON			CBYS	ABYS	ACYS
41	65																
42	66																
43	67																
44	68																
45	69																
46	70																
47	71																
48	72																
49	73																
4A	74																
4B	75																
4C	76																

Note2: Set 0 in blank columns.

Sub Address		MSB															LSB	
Hex	Dec	15	14	13	12	11	10	9	8	7	6	5	4	3	2	1	0	
4D	77																	
4E	78																	
4F	79																	
50	80																	
51	81																	
52	82																	
53	83																	
54	84																	
55	85																	
56	86																	
57	87																	
58	88																	
59	89																	
5A	90																	
5B	91																	
5C	92																	
5D	93					RHMBLE11	→ 10	→ 9	→ 8	→ 7	→ 6	→ 5	→ 4	→ 3	→ 2	→ 1	→ 0	
5E	94					RHMBS11	→ 10	→ 9	→ 8	→ 7	→ 6	→ 5	→ 4	→ 3	→ 2	→ 1	→ 0	
5F	95							RVMBLE9	→ 8	→ 7	→ 6	→ 5	→ 4	→ 3	→ 2	→ 1	→ 0	
60	96							RVMBLS9	→ 8	→ 7	→ 6	→ 5	→ 4	→ 3	→ 2	→ 1	→ 0	
61	97	MFRAIQ7	→ 6	→ 5	→ 4	→ 3	→ 2	→ 1	→ 0	MFRAY7	→ 6	→ 5	→ 4	→ 3	→ 2	→ 1	→ 0	
62	98																	
63	99																	
64	100					RMHCNT11	→ 10	→ 9	→ 8	→ 7	→ 6	→ 5	→ 4	→ 3	→ 2	→ 1	→ 0	
65	101							RMVCNT9	→ 8	→ 7	→ 6	→ 5	→ 4	→ 3	→ 2	→ 1	→ 0	
66	102							RMHTES10	→ 9	→ 8	→ 7	→ 6	→ 5	→ 4	→ 3	→ 2	→ 1	→ 0

Note2: Set 0 in blank columns.

Sub Address		MSB															LSB
Hex	Dec	15	14	13	12	11	10	9	8	7	6	5	4	3	2	1	0
67	103								RMVTE8	→ 7	→ 6	→ 5	→ 4	→ 3	→ 2	→ 1	→ 0
68	104										RMHMOV6	→ 5	→ 4	→ 3	→ 2	→ 1	→ 0
69	105	RMWSEL									RMVMOV6	→ 5	→ 4	→ 3	→ 2	→ 1	→ 0
6A	106	YSCMVON				YSAMVON	YSBMVON	RHMDN	RMHUP	RMVSEL4	→ 3	→ 2	→ 1	RMHSEL4	→ 3	→ 2	→ 1
6B	107	FHWE3	→ 2	→ 1	→ 0	RHFRE11	→ 10	→ 9	→ 8	→ 7	→ 6	→ 5	→ 4	→ 3	→ 2	→ 1	→ 0
6C	108	FHWS3	→ 2	→ 1	→ 0	RHFRS11	→ 10	→ 9	→ 8	→ 7	→ 6	→ 5	→ 4	→ 3	→ 2	→ 1	→ 0
6D	109	FVWE3	→ 2	→ 1	→ 0	FHEON	FHSON	RVFRE9	→ 8	→ 7	→ 6	→ 5	→ 4	→ 3	→ 2	→ 1	→ 0
6E	110	FVWS3	→ 2	→ 1	→ 0	FVEON	FVSON	RVFRS9	→ 8	→ 7	→ 6	→ 5	→ 4	→ 3	→ 2	→ 1	→ 0
6F	111																
70	112																
71	113																
72	114																
73	115																
74	116																
75	117																
76	118																
77	119																
78	120																
79	121																
7A	122																
7B	123																
7F	127								AUTOIN								

Note2: Set 0 in blank columns.

## Outline of I<sup>2</sup>C Bus Control Format

I<sup>2</sup>C bus control for the TC90A31F conforms to the Philips format.

### Data Transfer Format

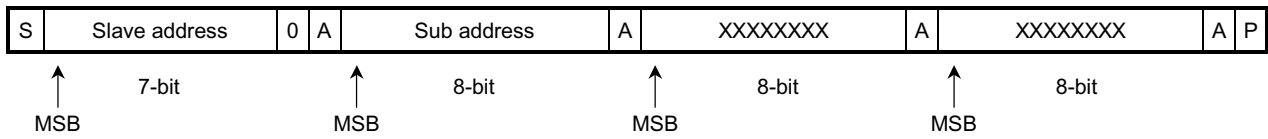

S: start condition

P: stop condition

A: acknowledge

(1) Start and stop conditions

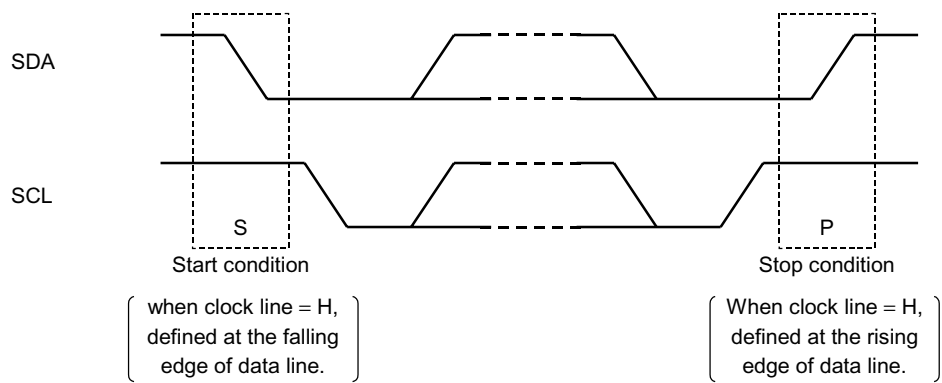

(2) Bit transfer

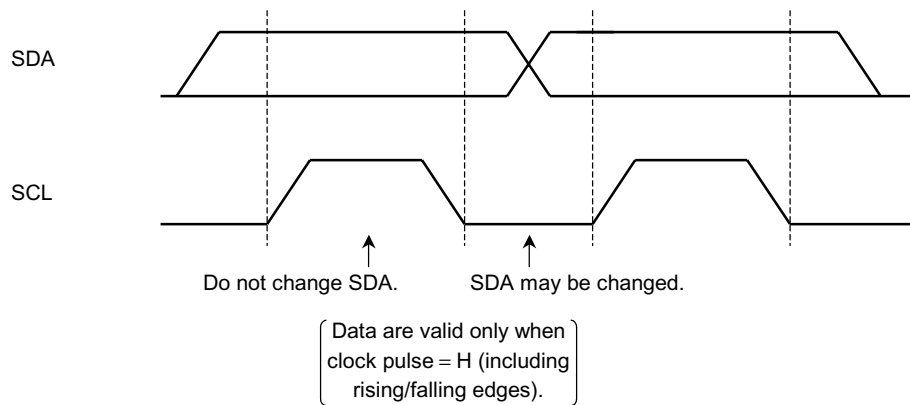

(3) Acknowledge

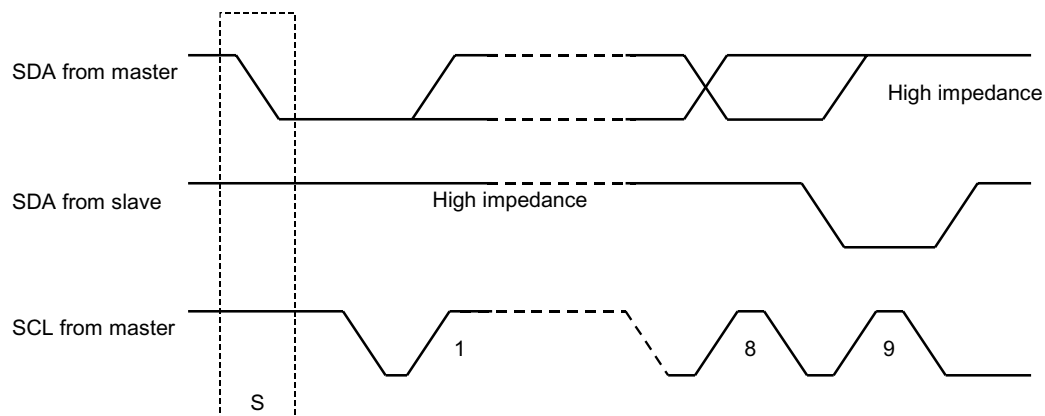

(4) Slave address

A6	A5	A4	A3	A2	A1	A0	R/W
0	0	1	0	0	1	1	0

Purchase of TOSHIBA I<sup>2</sup>C components conveys a license under the Philips I<sup>2</sup>C Patent Right to use these components in an I<sup>2</sup>C system, provided that the system conforms to the I<sup>2</sup>C Standard Specification as defined by Philips.

## I<sup>2</sup>C Bus Functions (write)

Sub Address		Data	Signal Name	Function
Hex	Dec			
1D	29	15	DWFIL	Image compression switching PAP (L) image compression (H)
		14	JSWAP	Memory write control S/E inversion inversion (H) (used at right-and-left picture swapping)
		10-0	WHST10-0	Horizontal write start position
1E	30	15-12	WHMOD3-0	Horizontal reduction ratio 1/16 (0H) 1/8 (1H) 1/5 (2H) 1/4 (3H) 1/3 (4H) 3/8 (5H) 2/5 (6H) 1/2 (7H) 3/5 (8H) 5/8 (9H) 2/3 (AH) 3/4 (BH) 4/5 (CH) 7/8 (CH) 15/16 (EH) 16/16 (FH)
		11	WCKINV	Memory WCK phase inversion inversion (H)
		10-0	WHED10-0	Horizontal write stop position
1F	31	15	WEYINV	Memory Y-signal WE polarity inversion polarity inversion (H)
		13-12	WEYDL1-0	Memory Y-signal WE delay adjustment delay 0 (0) delay 1 (1) delay 2 (2) delay-1 (3)
		11	IENINV	Memory IE polarity inversion polarity inversion (H)
20	32	10-0	KWST10-0	Horizontal filter processing start position
		15	WECINV	Memory C-signal WE polarity inversion polarity inversion (H)
		14	WECDL2	normal (L) when 2M memory mode H3/4 (WHMOD3-0 = BH) is set (H)
		13-12	WECDL1-0	Memory C-signal WE delay adjustment delay 0 (0) delay 1 (1) delay 2 (2) delay-1 (3)
		11	WEPCM	Memory WE for 1-picture 1-picture processing (H)
		10-0	KWED10-0	Horizontal filter processing stop position
21	33	15	WHRFTH	HREF signal through function phase comparison (L) through (H)
		14	WHRFIV	Polarity inversion of HREF signal polarity inversion (H)
		13	WHINV2	Polarity inversion of HD signal for phase comparison polarity inversion (H)
		12	MOH	Field memory use signal YCS (L) PAP IC (H)
		11-0	SHRST11-0	S-system horizontal phase reference
22	34	15	PCMAIN	1-picture processing 1-picture processing (H)
		14	SIQINV	2M memory S system/4M memory-I/Q inversion I/Q inversion (H)
		13	EIQINV	2M memory E system-I/Q inversion I/Q inversion (H)
		11-0	EHRST11-0	E-system horizontal phase reference
23	35	12	WCKEON	E-system operating control E-system operation (H)
		11-0	PHREF11-0	PLL divider counter cycle for write NTSC4M/2M [95D]
24	36	15-8	SCLPST7-0	S-system clamp pulse start position
		7-0	SCLPED7-0	S-system clamp pulse stop position (start setting value < stop setting value)
25	37	15-8	ECLPST7-0	E-system clamp pulse start position
		7-0	ECLPED7-0	E-system clamp pulse stop position (start setting value < stop setting value)
26	38	15	WPLHS	Through function for S-system phase comparison HD signal through (H)
		14	EPLHS	Through function for E-system phase comparison HD signal through (H)
		13	EHINV	E-system HD polarity inversion at negative polarity input (L) polarity inversion (H)
		12	EVINV	E-system VD polarity inversion at negative polarity input (L) polarity inversion (H)
		11	NTPAL	NTSC/PAL switching for typical detector circuit NTSC (L) PAL (H)
		7	RPLHS	Through function for phase comparison HD signal for read through (H)
		6-0	HDWDT7-1	Pulse width adjustment function for phase comparison HD signal for read (change in units of W1CK)

Sub Address		Data	Signal Name	Function
Hex	Dec			
27	39	15	WHIHYO	S-system forced non-standard forced non-standard (H)
		14	WKHYO	S-system forced standard forced standard (H)
		13	WHINV	S-system HD signal polarity inversion at negative polarity input (L) polarity inversion (H)
		12	WVINV	S-system VD signal polarity inversion at negative polarity input (L) polarity inversion (H)
		11	WS262	S/E-system odd/even inversion 263 (L) 262 (H)
		10-8	HYJ3-1	Read S/E-system standard inversion slice level
		7-3	WVMSK7-3	S/E-system VD masking (each 16 lines)
		2	WOERSTN	Odd/even generator circuit clear stop
		1	EHIHYO	E-system forced non-standard forced non-standard (H)
		0	EKHYO	E-system forced standard forced standard (H)
28	40	15	RHIHYO	Forced non-standard for read forced non-standard (H)
		14	RKHYO	Forced standard for read forced standard (H)
		13	RHINV	Horizontal direction (HD) signal polarity inversion for read at negative polarity input (L) polarity inversion (H)
		12	RVINV	Vertical direction (VD) signal polarity inversion for read at negative polarity input (L) polarity inversion (H)
		11	RS262	Odd/even inversion for read 263 (L) 262 (H)
		10-8	HIJ3-1	S/E-system non-standard decision inversion slice level for read
		7-0	RVMSK7-0	VD masking for read (each two lines)
29	41	15	JVLOCHG	Change of vertical reduction center center of gravity change (H)
		14	JFMINT	Field memory initialize initialize (H)
		13	JVLOINV	Change of vertical reduction center direction normal (H)
		12	WKYFRM	Forced frame write processing forced frame (H)
		11	MAINRST	Memory reset switching at 1-picture processing 1-picture processing (H)
		10	MSKOFF	VD masking function off during WE VD mask off (H)
		9	VFILOFF	Fixed to L
		8-0	WVST8-0	Vertical write start line
2A	42	15	JWRTON	Write on/off still (L) live (H)
		14	POEINV	Fixed to L
		13	INT3S2	Memory initialize width change 3V (L) 2V (H)
		9	RSTDEL	Fixed to L
		8-0	WVED8-0	Vertical write stop line
2B	43	15	FIELD	Only 1-field write 1-field (H)
		14-13	VSPD1-0	Scroll down speed change
		12	JVSCRL	Scroll down on/off off (L) on (H)
		8-0	VL8-0	Number of lines to be moved for vertical reduction center normal [001H]
2C	44	15	MWBACK	Background on/off off (L) on (H)
		14-9	BVIE5-0	[2CH: MWBACK = 1] block vertical interval
		8-0	BVWE8-0	[2CH: MWBACK = 1] number of block lines

Sub Address		Data	Signal Name	Function
Hex	Dec			
2D	45	15	MULT	Multi-search strobe function on/off on (H)
		14	STREND	Fixed to L
		13	VSKOFF	[2DH: MULT = 1] write block position change function on (L) off (H) When set to off, only one picture (upper left) of strobe mode is motion picture. (effective for ATSTRV, H = 1)
		12	KSKOFF	[2DH: MULT = 1] reference skip function off on (L) off (H)
		10	RANDM	Fixed to L
		9-0	HIE9-0	[2DH: MULT = 1] horizontal skip width [2CH: MWBACK = 1] number of block pixels
2E	46	15-10	BHIE5-0	[2CH: MWBACK = 1] block horizontal interval
		9-0	KJH9-0	[2DH: KSKOFF = 0] reference skip horizontal position
2F	47	15-12	BVRN3-0	[2CH: MWBACK = 1] number of vertical blocks (setting value: number of vertical blocks – 1)
		11-8	BHRN3-0	[2CH: MWBACK = 1] number of horizontal blocks (setting value: number of horizontal blocks – 1)
		7-0	KJV7-0	[2DH: KSKOFF = 0] reference skip vertical position
30	48	15-12	ATMV3-0	Number of strobe mode vertical blocks (setting value: number of vertical blocks – 1)
		11-8	ATMH3-0	Number of strobe mode horizontal blocks (setting value: number of horizontal blocks – 1)
		7-0	ATFLD7-0	[2DH: MULT = 1] write field interval (00H = 2Fi, 01H = 4Fi···)
31	49	15-12	STMV3-0	[2DH: MULT = 1] vertical block position for 1 motion picture (specified block – 1)
		11-8	STMH3-0	[2DH: MULT = 1] horizontal block position for 1 motion picture (specified block – 1)
		7-0	STVS7-0	[2DH: MULT = 1] number of vertical block lines
32	50	13	ATSTRV	[2DH: MULT = 1] vertical strobe function multi search (L) strobe (H)
		12	ATSTRH	[2DH: MULT = 1] horizontal strobe function multi search (L) strobe (H)
		11	AT2CHG	[2DH: MULT = 1] strobe vertical 2-row write function on (H)
		9-0	STHS9-0	[2DH: MULT = 1] number of horizontal block pixels (setting value: number of block pixels – 3)
33	51	15-12	CHMV3-0	[32H: AT2CHG = 1] strobe row 2
		11-8	CHMH3-0	[32H: AT2CHG = 1] strobe line 2
		7-4	ATLV3-0	[32H: AT2CHG = 1] strobe row 1
		3-0	ATLH3-0	[32H: AT2CHG = 1] strobe line 1
34	52	9-0	RH9-0	[2DH: MULT = 1] number of multi search horizontal pixels (setting value: horizontal pixels – 3) = 15H: field memory horizontal read size In Multi Search, Strobe mode Number of pixels = (number of block pixels) × (number of horizontal blocks)
35	53	15	YCMF2	YCMIX signal (M/N type) polarity inversion polarity inversion (H)
		14	YCMF1	YCMIX signal (before multiplier) polarity inversion polarity inversion (H)
		13	YCMN	Compression switching M/N compression (L) 1/N compression (H)
		12	C2HFT	Color signal (I/Q) binary interpolation circuit on/off on (H)
		11	Y2HFT	Luminance signal binary interpolation circuit on/off on (H)
		10	W1NSEL	Reduction processor circuit switching M/N (L) 1/N (H)
		9	THRUUY	Through output on/off for Y-signal only on (H)
		8	KMODE	Horizontal filter coefficient mode switching 1/N processing (L) M/N processing (H)
		7	THRUYC	[35H: YCMN = 1] horizontal filter through on/off on (H)
		6-4	YDL2-0	Y signal delay adjustment
		3-1	KTC-A	Number of filter coefficients 0Hex = 1, 1Hex = 2, ··· 7Hex = 8
0	OFSET	Fixed to L		



Sub Address		Data	Signal Name	Function
Hex	Dec			
36	54	15-0	KD15-0	Horizontal filter coefficient 1 (KD 3-0)~coefficient 8 (KD31-28)
37	55	15-0	KD31-16	1/N compression: 10H-setting value (complement) M/N compression: Hex
38	56	7	HFSPAIV	[4M mode] polarity inversion of Y/C separation control signal before HFIL stage polarity inversion (H)
		3	YLPFCH	LPF for Y signal switching Stage 2 (L) stage 1 (H)
		2	THRUC	C-signal-only through output on/off on (H)
		1	CLPFTH	LPF for C signal on/off on (H)
		0	YLPFTH	LPF for Y signal on/off on (H)
39	57	11-8	VFN3-0	Vertical compression ratio (setting value: denominator – 1) (1/2 → 1, 1/3 → 2, 1/4 → 3, 3/4 → 3, 1/5 → 4, 1/6 → 5, 1/8 → 7) Select from the above reduction ratios.
		5	VFYTH	Vertical filter through on/off on (H)
		4-0	VKOS4-0	RAM address specification for vertical filter coefficient Set according to the specified vertical reduction ratio as follows: 1/3 (00H), 1/4 (03H), 1/2 (07H), 3/4 (09H), 5/6 (0DH), 1/8 (13H), 1/5 (1BH)
3B	59	11	SYCINV	Polarity inversion of Y/C separation control signal polarity inversion (H)
		10	PCMAIN	1-picture processing 1-picture processing (H)
		8	STHRU	SEL block through on/off on (H)
7F	127	8	AUTOIN	Vertical filter SRAM data transmission Auto Increment mode [H] Set to L for no vertical reduction.

## I<sup>2</sup>C Bus Functions (read)

Sub Address		Data	Signal Name	Function
Hex	Dec			
00	00	15-13	MYPH2-0	Y signal phase adjustment for read
		12	MIQPH0	I/Q signal phase adjustment for read
		11	RRSTINV	Polarity inversion of field memory read reset (RRST) signal inversion (H)
		10	RCKINV	Polarity inversion of field memory read clock (PCK) signal inversion (H)
		9-8	RREPH1-0	Phase adjustment of field memory read enable (RRE) signal inversion (H)
		7	M4M2	4M memory/2M memory mode switching 4M (L) 2M (H)
		6	SESW	S/E system control switching S system (L) E system (H)
01	01	13	YSBACT	YS off (L) on (H)
		12	FRACL	Frame signal off (L) on (H)
		11	YSCCLR	YS (E system) off (L) on (H)
		10	YSBCLR	YS (external) off (L) on (H)
		9	YSACLR	YS (S system) off (L) on (H)
02	02	15-12	MBLKIQ7-4	Blanking level (I)
		11-8	MBLKIQ3-0	Blanking level (Q)
		7-0	MBLKY3-0	Blanking level (Y)
03	03	15-12	MMWIQ7-0	Background level (I)
		11-8	MMWIQ3-0	Background level (Q)
		7-0	MMWY7-0	Background level (Y)
09	09	11-0	PHYSAE11-0	YS horizontal stop position (S system)
0A	10	11-0	PHYSAS11-0	YS horizontal start position (S system)
0B	11	9-0	RVYSAE9-0	YS vertical stop position (S system)
0C	12	9-0	RVYSAS9-0	YS vertical start position (S system)
0D	13	11-0	RHYSBE11-0	YS horizontal stop position (external)
0E	14	11-0	RHYSBS11-0	YS horizontal start position (external)
0F	15	9-0	RVYSBE9-0	YS vertical stop position (external)
10	16	9-0	RVYSBS9-0	YS vertical start position (external)
11	17	11-0	RHYSCE11-0	YS horizontal stop position (E system)
12	18	11-0	RHYSCE11-0	YS horizontal start position (E system)
13	19	9-0	RVYSCE9-0	YS vertical stop position (E system)
14	20	9-0	RVYSCS9-0	YS vertical start position (E system)
15	21	11-0	RHSIZ11-0	Field memory horizontal read size (set number of horizontal pixels – 3)
16	22	9-0	RVSIZ9-0	Field memory read size (vertical)
17	23	14	ROEFON	Field memory read/write phase control for write on (H)
		13	RGAME	Game mode display on (H)
		12	DWSW	PIP display (vertical 1/2 size or smaller) PIP (H)
		11-0	RRH11-0	Field memory horizontal read start position
18	24	15	FRFI	Field/frame display switching frame (L) field (H)
		14	ROEALT	Odd/even switching
		13	RFISW	Field/frame display switching (field memory read/write phase control on/off) frame (H) field (L)
		12	RFALT	Field memory read/write phase control at memory read normal (H)
		9-0	RRV9-0	Field memory vertical read start position

Sub Address		Data	Signal Name	Function
Hex	Dec			
19	25	9-0	RWRN9-0	Field memory read/write phase control start (at standard)
1A	26	9-0	RWRA9-0	Field memory read/write phase control start (at non-standard) 19H and 1AH are control registers at frame display (PIP, DW). 19H is for when main/sub picture is standard signal; 1AH is for when either main/sub picture is non-standard signal. How to calculate the setting value: Sub address 15H: field memory horizontal read size = A Sub address 16H: field memory vertical read size = B $\frac{(A + 3) \times B - 600}{256}$ (calculate in decimal) Input the result of the above calculation in hexadecimal (19H and 1AH have the same value).
1B	27	15 14 13 12 11-0	RHRFTH RHRFIV RHINV2 RCKCHG PRHP11-0	Control output mode for RHREF signal output control forced output (H) Polarity inversion of RHREF signal polarity inversion (H) HD polarity inversion of RHREF signal output control polarity inversion (H) Read clock switching normal (L) Read horizontal reference (PLL counter decoded value)
1C	28	11-0	RPLLPH11-0	PLL counter for read (fH setting)
40	64	6 5 2 1 0	FRAON BWASKON CBYS ABYS ACYS	Frame signal off (L) on (H) Background/image switching background (L) image (H) (Set background to YIQ level at 03H.) YSB > YSC (L) YSB < YSC (H) (YSA: S system, YSB: external, YSC: E system) YSA > YSB (L) YSA < YSB (H) YSA > YSC (L) YSA < YSC (H)
5D	93	11-0	RHMBLE11-0	Blanking horizontal stop position
5E	94	11-0	RHMBLS11-0	Blanking horizontal start position
5F	95	9-0	RVMBLE9-0	Blanking vertical stop position
60	96	9-0	RVMBLS9-0	Blanking vertical start position
61	97	15-12 11-8 7-0	MFRAIQ7-4 MFRAIQ3-0 MFRAY7-0	Frame level (I) Frame level (Q) Frame level (Y)
64	100	11-0	RMHCNT11-0	Wipe signal horizontal reference (center)
65	101	9-0	RMVCNT9-0	Wipe signal vertical reference (center)
66	102	10-0	RMHTES10-0	Wipe signal horizontal phase range (width)
67	103	8-0	RMVTES8-0	Wipe signal vertical phase range (width)
68	104	6-0	RMHMOV6-0	Wipe signal horizontal operating speed
69	105	15 6-0	RMWSEL RMVMOV6-0	Wipe signal system select window (L) cross (H) Wipe signal vertical operating speed

Sub Address		Data	Signal Name	Function
Hex	Dec			
6A	106	15	YSCMVON	E-system wipe off (L) on (H)
		11	YSAMVON	S-system wipe off (L) on (H)
		10	YSBMVON	External wipe off (L) on (H)
		9	RMHDN	Wipe counter up (L) down (H)
		8	RMHUP	Wipe counter reset reset (L)
		7	RMVSEL4	Vertical wipe (top) off (L) on (H)
		6	RMVSEL3	Vertical wipe (bottom) off (L) on (H)
		5	RMVSEL2	Fixed to H
		4	RMVSEL1	Fixed to L
		3	RMHSEL4	Horizontal wipe (right) off (L) on (H)
		2	RMHSEL3	Horizontal wipe (left) off (L) on (H)
		3-2	RMHSEL2	Fixed to H
		1-0	RMHSEL1	Fixed to L
6B	107	15-12	FHWE3-0	Frame horizontal width (stop position)
		11-0	RHFRE11-0	Frame horizontal stop position
6C	108	15-12	FHWS3-0	Frame horizontal width (start position)
		11-0	RHFRS11-0	Frame horizontal start position
6D	109	15-12	FVWE3-0	Frame vertical width (stop position)
		11	FHEON	Frame horizontal (stop position) off (L) on (H)
		10	FHSON	Frame horizontal (start position) off (L) on (H)
		9-0	RVFRE9-0	Frame vertical stop position
6E	110	15-12	FVWS3-0	Frame vertical width (start position)
		11	FVEON	Frame vertical (stop position) off (L) on (H)
		10	FVSON	Frame vertical (start position) off (L) on (H)
		9-0	RVFRS9-0	Frame vertical start position

**Description of I<sup>2</sup>C Bus Data for Read**

**1. Frame Display**

- (1) Y signal can be set with 8-bit precision; I/Q signal with 4-bit precision.
- (2) Frame width can be set in 4 bits (16 types).
- (3) Set frame details using the following registers:
  - ① RHFRS: frame horizontal start position
  - ② RHFRE: frame horizontal stop position
  - ③ FHWS: frame horizontal width (start position)
  - ④ FHWE: frame horizontal width (stop position)
  - ⑤ RVFRS: frame vertical start position
  - ⑥ RVFRE: frame vertical stop position
  - ⑦ FVWS: frame vertical width (start position)
  - ⑧ FVWE: frame vertical width (stop position)

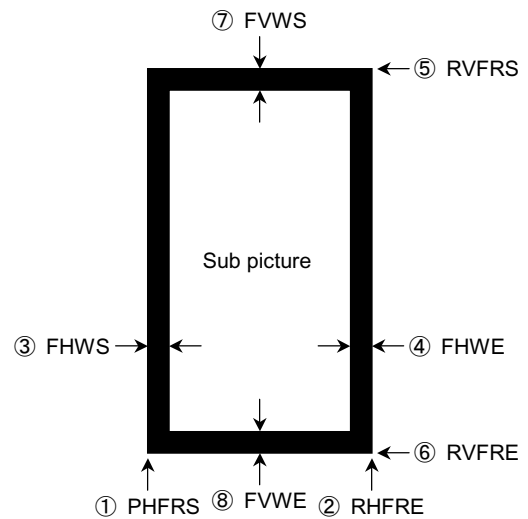

**2. YS and Blanking Setting**

- (1) Set the YS signal timing using the following registers.
- (2) Set horizontal start and stop positions, and vertical start and stop positions for blanking.

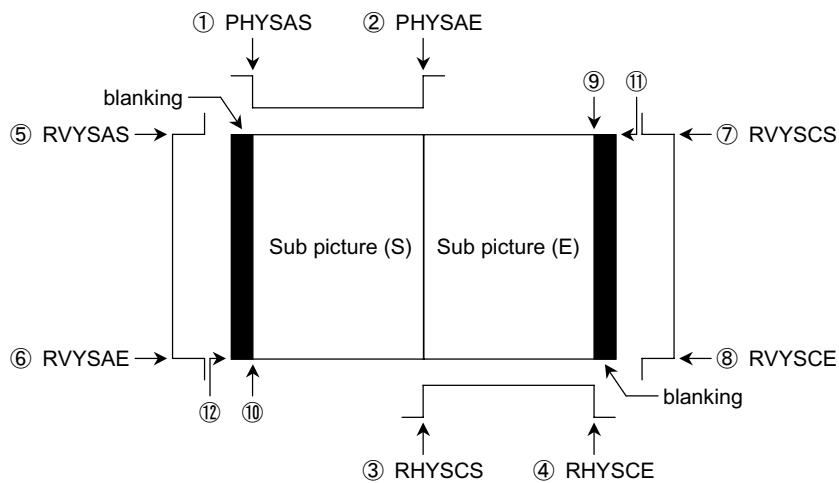

- |   |   |
|---|---|
| ① YS horizontal start position (S system) | ⑦ YS vertical start position (E system) |
| ② YS horizontal stop position (S system)  | ⑧ YS vertical stop position (E system)  |
| ③ YS horizontal start position (E system) | ⑨ Blanking horizontal start position    |
| ④ YS horizontal stop position (E system)  | ⑩ Blanking horizontal stop position     |
| ⑤ YS vertical start position (S system)   | ⑪ Blanking vertical start position      |
| ⑥ YS vertical stop position (S system)    | ⑫ Blanking vertical stop position       |

## Settings of Special Effect Functions

### 3. Scroll Down

Special effect function used when selecting 2-picture, 1-picture, or PIP display. The function freezes the image signal before selection then moves the image after selection from the top.

(1) 1-field display

18h (24) FRFI<sup>⑮</sup> = H (field display)  
FRISW<sup>⑬</sup> = L (field display)

(2) Write stop

2Ah (42) JWRTON<sup>⑮</sup> = L (Write stop)

(3) Select channel change start

Change channel after write actually stopped.

(4) Scroll down function environment setting

29h (41) MAINRST<sup>⑩</sup> = H WKYFRM<sup>⑫</sup> = H  
2Bh (43) FIELD<sup>⑮</sup> = H

(5) Scroll down start

2Bh (43) JVSCRL<sup>⑫</sup> = H

(6) Write start

2Ah (42) JWRTON<sup>⑮</sup> = H

(7) Scroll down standby time (do not change frame processing during standby)

2BH: VSPD		NTSC	PAL
Setting value	Number of write lines	(240 valid lines)	(282 valid lines)
LL	2	120Fr (4.0 s)	141Fr (5.6 s)
LH	4	60Fr (2.0 s)	70Fr (2.8 s)
HL	6	40Fr (1.3 s)	47Fr (1.9 s)
HH	7	34Fr (1.1 s)	40Fr (1.6 s)

(8) Write processing change (frame processing)

29h(41) WKYFRM<sup>⑫</sup> = L

(after 1 field)

29h(41) MAINRST<sup>⑩</sup> = L

2Bh(43) FIELD<sup>⑮</sup> = L

JVSCRL<sup>⑫</sup> = L

(9) Read processing change (frame processing)

After sending write processing data, count four fields of VD for read, then send the following data.  
(After new image signal is written to memory, frame is displayed.)

18h (24) FRFI<sup>⑮</sup> = L  
FRISW<sup>⑬</sup> = H

## Settings of Special Effect Functions

### 4. Wipe Function

- (1) Wipe on/off
 

6Ah (106)	YSCMVON <sup>⑮</sup>	E system wipe	on (H)/off (L)
	YSAMVON <sup>⑰</sup>	S system wipe	on (H)/off (L)
	YSBMVON <sup>⑱</sup>	External wipe	on (H)/off (L)
- (2) Wipe signal center and width settings (horizontal and vertical)
 

64h (100)	RMHCNT	Wipe signal horizontal reference (center)	
65h (101)	RMVCNT	Wipe signal vertical reference (center)	
66h (102)	RMHTES	Wipe signal horizontal phase adjustment (width)	
67h (103)	RMVTES	Wipe signal vertical phase adjustment (width)	
- (3) Wipe signal speed settings (count number of vertical sync signal)
 

68h (104)	RMHMOV	Wipe signal horizontal operating speed	large → slow	small → fast
69h (105)	RMVMOV	Wipe signal vertical operating speed	large → slow	small → fast
- (4) Wipe direction setting
 

6Ah (106)	RMVSEL4	Up	on (H)/off (L)
	RMVSEL3	Down	on (H)/off (L)
	RMHSEL4	Right	on (H)/off (L)
	RMHSEL3	Left	on (H)/off (L)
- (5) Wipe type setting
 

69h (105)	RMWSEL	window (L)	cross (H)
-----------	--------	------------	-----------

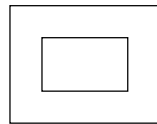

window

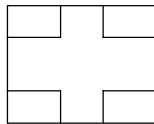

cross

- (6) Wipe operating control
 

6Ah (106)	RMHDH	Wipe counter	UP (L)/DOWN (H)
	RMHUP	Wipe counter reset	reset (L)

  - (1) Start from wipe close
    - ① RMHDN = L, RMHUP = L (wipe close: initial state)
    - ② RMHDN = L, RMHUP = H
    - ③ RMHDN = H, RMHUP = H (wipe open)
  - (2) Start from wipe open
    - ① RMHDN = H, RMHUP = L (wipe open: initial state)
    - ② RMHDN = H, RMHUP = H
    - ③ RMHDN = L, RMHUP = H (wipe close)

\*: Send in order of ① to ③.

\*: When the center is changed, make initial settings.

## Maximum Ratings ( $V_{SS} = 0\text{ V}$ , $T_a = 25^\circ\text{C}$ )

Characteristics	Symbol	Rating	Unit
Power supply voltage	$V_{SS}$ , $V_{DD}$	$V_{SS}$ to $V_{SS} + 4.0$	V
Input voltage	$V_{IN1}$	-0.3 to $V_{DD} + 0.3$	V
	$V_{IN2}$	-0.3 to 525 (Note3)	
Power dissipation	$P_D$ (Note4)	2000	mW
Storage temperature	$T_{stg}$	-55 to 125	$^\circ\text{C}$

Note3: Applicable to WVDE, WHDE, WCKE, WVDS, WHDS, WCKS, RDAC0 to RDAC7, RDAY0 to RDAY7, RCK, RHD, RVD, SCL, and SDA pins.

Note4: When using the IC at  $T_a = 25^\circ\text{C}$  or higher, reduce 20.0 mW per degree.

## Power Dissipation Reduction Against Higher Temperature (when mounted on board)

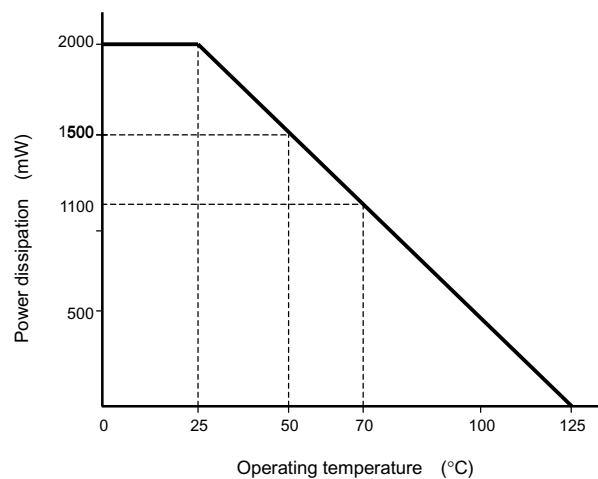

## Recommended Operating Conditions ( $V_{SS} = 0\text{ V}$ )

Characteristics	Symbol	Test Condition	Min	Typ.	Max	Unit
Power supply voltage	$V_{DD}$	—	3.0	3.3	3.6	V
Input voltage	$V_{IN}$	—	0	—	$V_{DD}$	V
Operating temperature	$T_{opr}$	—	-20	—	70	$^\circ\text{C}$



## Electrical Characteristics

### 1. DC Characteristics

Operating Conditions:  $V_{DD} = 3.0$  to  $3.6$  V,  $V_{IN} = 0$  to  $V_{DD}$ ,  $T_a = -20$  to  $70^\circ\text{C}$ ,  $V_{SS} = 0$

Characteristics		Symbol	Test Circuit	Test Condition	Min	Typ.	Max	Unit	Terminal	
Power dissipation		$I_{DD}$	—	NTSC	—	—	250	mA		
High-level input voltage	CMOS input	$V_{IH}$	—	—	$V_{DD} \times 0.8$	—	$V_{DD}$	V	(Note5)	
					$V_{DD} \times 0.8$	—	5.25		(Note9)	
	Schmitt trigger input				$V_{DD} \times 0.8$	—	5.25		(Note6)	
Low-level input voltage	CMOS input	$V_{IL}$	—	—	—	—	$V_{DD} \times 0.2$	V	(Note5)	
	Schmitt trigger input				—	—	$V_{DD} \times 0.2$		(Note9)	
					—	—	$V_{DD} \times 0.2$		(Note6)	
Input current	High level	$I_{IH}$	—	$V_{IN} = V_{DD}$	-10	—	10	$\mu\text{A}$	(Note5)	
	Low level	$I_{IL}$	—	$V_{IN} = V_{SS}$	-10	—	10		(Note6)	
Output voltage	High level	$V_{OH1}$	—		$I_{OH1} = -4$ mA	2.4	—	V	(Note7)	
		$V_{OH2}$			$I_{OH2} = -8$ mA	2.4	—		(Note8)	
	Low level	$V_{OL1}$			$I_{OL1} = 4$ mA	—	—		0.4	(Note7)
		$V_{OL2}$			$I_{OL2} = 8$ mA	—	—		0.4	(Note8)
Schmitt trigger hysteresis voltage		$V_H$	—	—	—	0.5	—	V	(Note6)	

Note5: TIN9-0, RMCKI, PWRST, TIMRST, IICNR, SADSEL, TST4-0, WHREFE, WHREFS, EWIEN, EWEN, EWRST, WIEN, WEN, WRST, WDAC7-0, WDAY7-0, REN, RRST, EREN, ERRST, RHREF, T107-100, EWMCK, WMCK, RMCK

Note6: WVDE, WHDE, WVDS, WHDS, RHD, RVD, SCL, SDA

Note7: WHREFE, WHREFS, EWIEN, EWEN, EWRST, WIEN, WEN, WRST, WDAC7-0, WDAY7-0, REN, RRST, EREN, ERRST, RHREF, SDA, T107-100, EWMCK, WMCK, RMCK

Note8: EWMCK, WMCK, RMCK

Note9: WCKE, WCKS, RDAC0-7, RDAY0-7, RCK

**2. AC Characteristics**

**Operating Conditions:  $V_{DD} = 3.3$  to  $3.6$  V,  $V_{IN} = 0$  to  $V_{DD}$ ,  $T_a = -20$  to  $70^\circ\text{C}$ ,  $V_{SS} = 0$**

Characteristics	Symbol	Test Circuit	Test Condition	Min	Typ.	Max	Unit	Re- marks
Operating frequency condition		—	NTSC mode		20	—	MHz	
Input setup time	TSUP1	—	Operating frequency: 20 MHz	5	—	—	ns	
	TSUP2			5	—	—		
Input hold time	THLD1	—	Operating frequency: 20 MHz	3	—	—	ns	
	THLD2			5	—	—		
Output transfer delay time	Tpd1	—	CL = 10.8 pF Vth = 2 V WCK = 37.8 MHz RCK = 37.8 MHz	5	—	20	ns	
	Tpd2			4	—	16		
	Tpd3			6	—	22		
	Tpd4			6	—	18		
	Tpd5			6	—	21		
	Tpd6			6	—	17		
	Tpd7			6	—	21		
	Tpd8			6	—	17		
	Tpd9			7	—	24		
	Tpd10			6	—	22		
	Tpd11			6	—	22		
	Tpd12			6	—	19		
	Tpd13			6	—	22		
	Tpd14			6	—	19		
	Tpd15			4	—	18		
	Tpd16			4	—	15		
	Tpd17			6	—	20		
	Tpd18			5	—	17		
	Tpd19			6	—	20		
	Tpd20			6	—	17		

**3. 1 ADC Characteristics**

**Operating Conditions:  $V_{DD} = 3.3$  V,  $T_a = -20$  to  $70^\circ\text{C}$ ,  $V_{SS} = 0$**

Characteristics	Symbol	Test Circuit	Test Condition	Min	Typ.	Max	Unit
Non-linear error	ILE	—	$V_{DD} = 3.3$ V DACK = 10 MHz	-3	—	+3	LSB
Differential non-linear error	DLE	—	$V_{DD} = 3.3$ V DACK = 10 MHz	-2	—	+2	LSB
Analog input voltage	FULL SCA	—	$V_{DD} = 3.3$ V DACK = 10 MHz	—	2.2	—	V
	ZERO SCA	—	$V_{DD} = 3.3$ V DACK = 10 MHz	—	1.1	—	V

### 3. 2 Clamp and Multiplexer

Operating Conditions:  $V_{DD} = 3.3\text{ V}$ ,  $T_a = -20\text{ to }70^\circ\text{C}$ ,  $V_{SS} = 0$

Characteristics	Symbol	Test Circuit	Test Condition	Min	Typ.	Max	Unit
Clamp Y	—	—	—	—	63	—	LSB
Clamp C	—	—	—	—	136	—	LSB
Multiplexer	—	—	—	—	5	—	MHz

### 4. DAC Characteristics

Operating Conditions:  $V_{DD} = 3.3\text{ V}$ ,  $T_a = -20\text{ to }70^\circ\text{C}$ ,  $V_{SS} = 0$

Characteristics	Symbol	Test Circuit	Test Condition	Min	Typ.	Max	Unit
Non-linear error	ILE	—	$V_{DD} = 3.3\text{ V}$ DACK = 20 MHz	-3	—	+3	LSB
Differential non-linear error	DLE	—	$V_{DD} = 3.3\text{ V}$ DACK = 20 MHz	-2	—	+2	LSB
Analog input voltage	FULL SCA	VIFS	$V_{DD} = 3.3\text{ V}$ DACK = 20 MHz	—	—	$V_{DD}$	V
	ZERO SCA	VIZS	$V_{DD} = 3.3\text{ V}$ DACK = 20 MHz	$V_{REF}$	—	—	V

**AC Characteristic Timing Charts**

**Write**

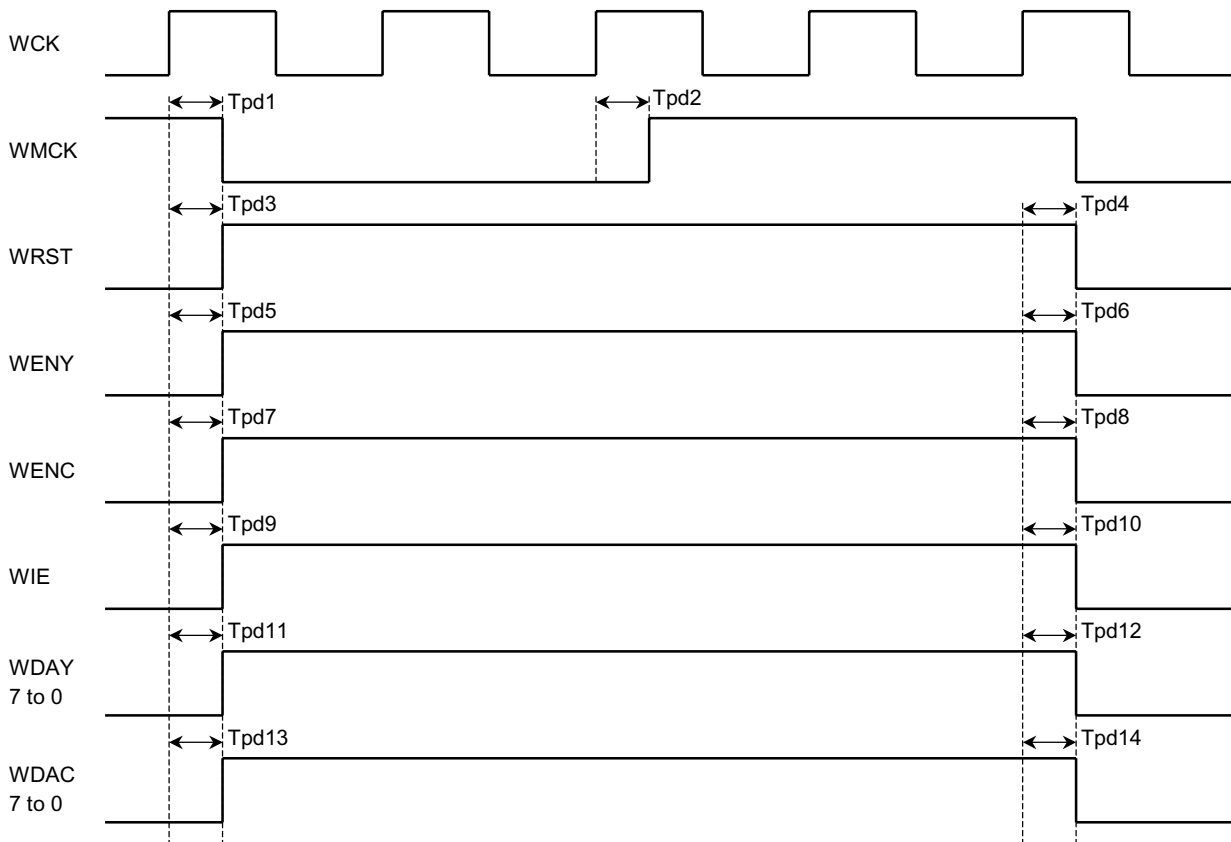

**Read**

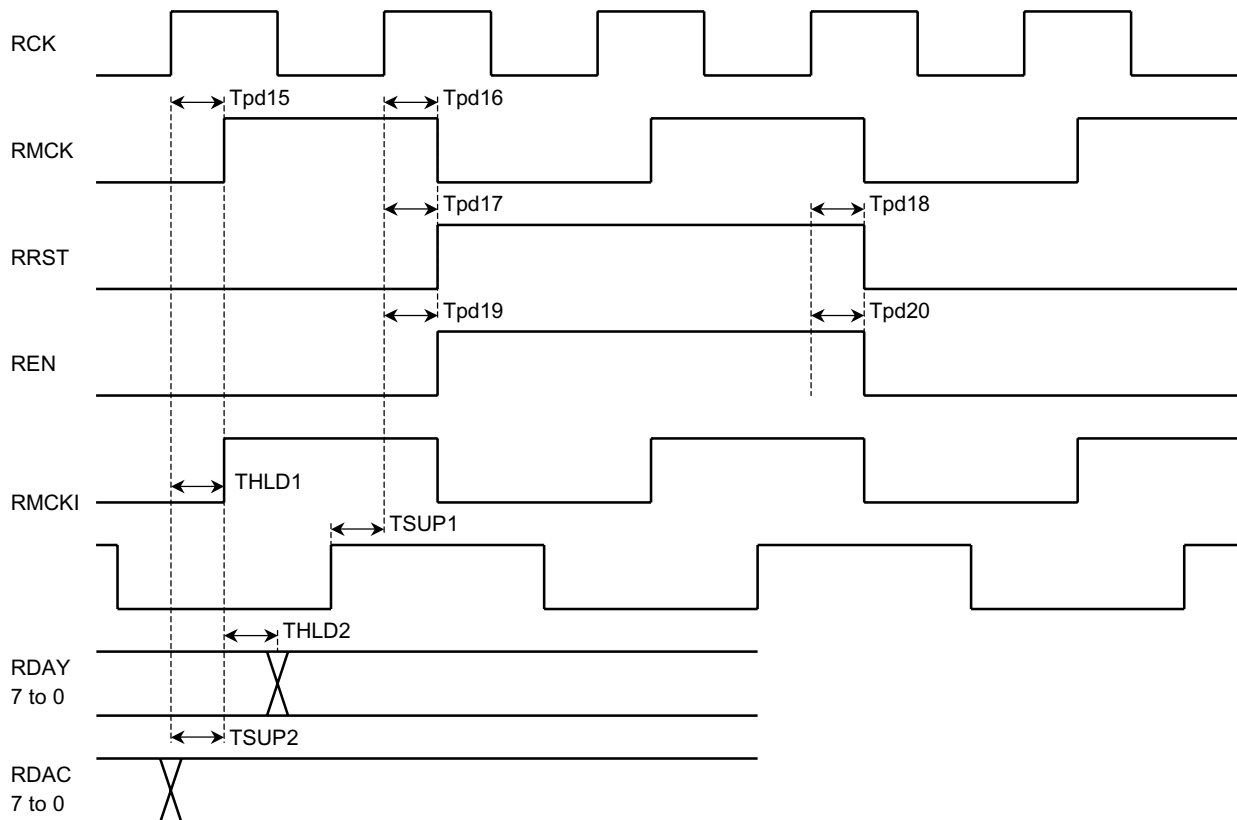

Application Circuit

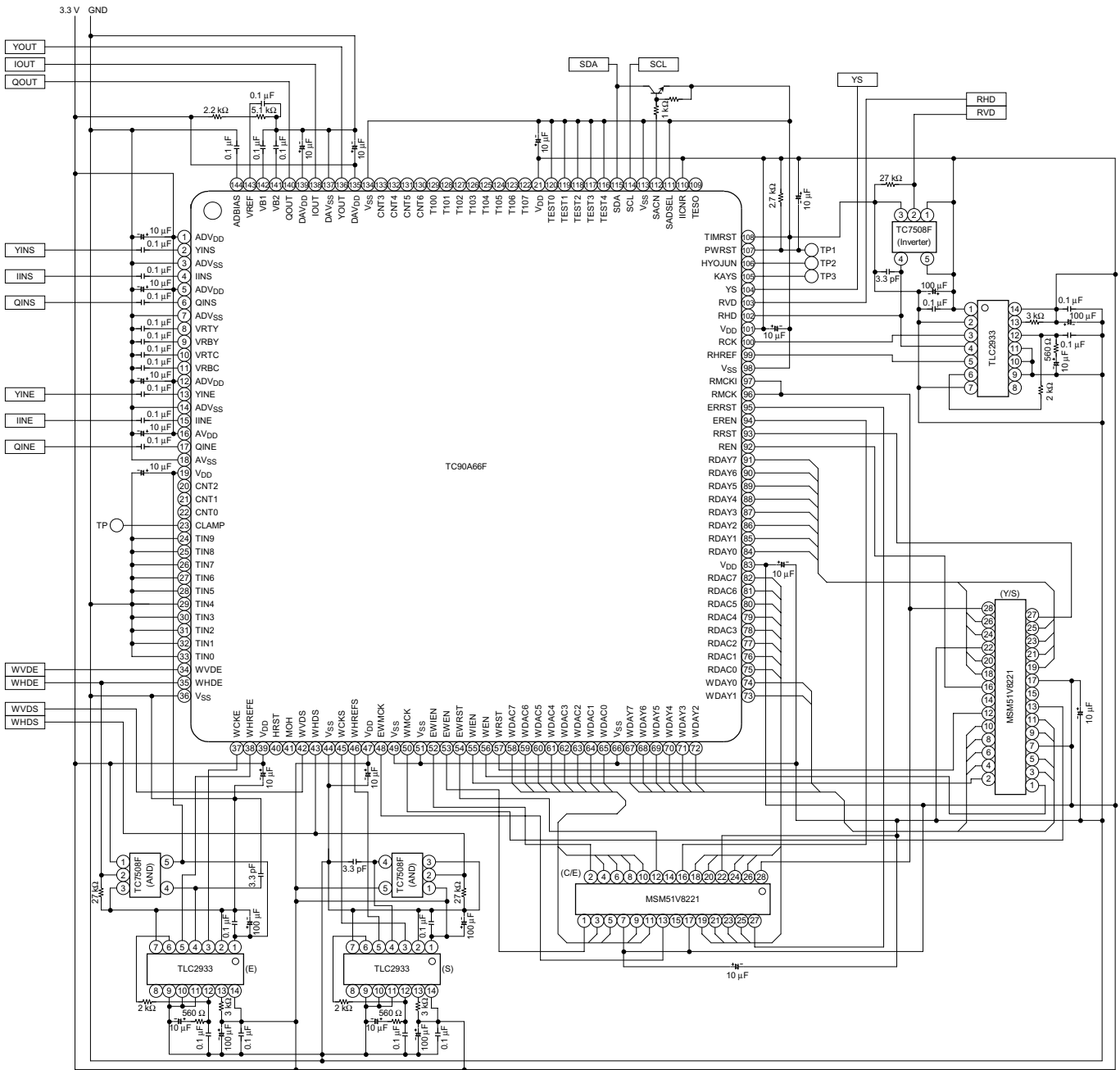

**Package Dimensions**

QFP144-P-2626-0.65B

Unit : mm

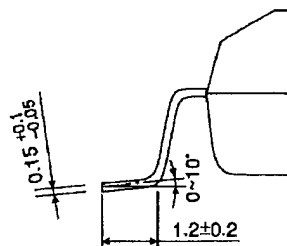
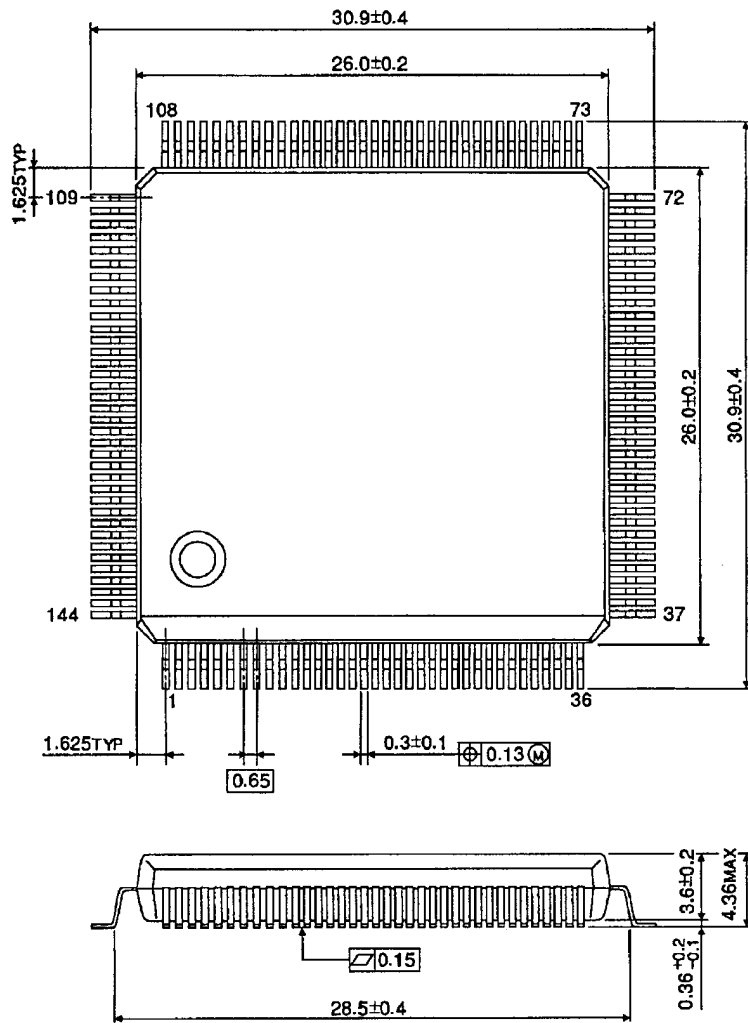

Weight: 4.64 g (typ.)

**RESTRICTIONS ON PRODUCT USE**

000707EBA

- TOSHIBA is continually working to improve the quality and reliability of its products. Nevertheless, semiconductor devices in general can malfunction or fail due to their inherent electrical sensitivity and vulnerability to physical stress. It is the responsibility of the buyer, when utilizing TOSHIBA products, to comply with the standards of safety in making a safe design for the entire system, and to avoid situations in which a malfunction or failure of such TOSHIBA products could cause loss of human life, bodily injury or damage to property.  
In developing your designs, please ensure that TOSHIBA products are used within specified operating ranges as set forth in the most recent TOSHIBA products specifications. Also, please keep in mind the precautions and conditions set forth in the "Handling Guide for Semiconductor Devices," or "TOSHIBA Semiconductor Reliability Handbook" etc..
- The TOSHIBA products listed in this document are intended for usage in general electronics applications (computer, personal equipment, office equipment, measuring equipment, industrial robotics, domestic appliances, etc.). These TOSHIBA products are neither intended nor warranted for usage in equipment that requires extraordinarily high quality and/or reliability or a malfunction or failure of which may cause loss of human life or bodily injury ("Unintended Usage"). Unintended Usage include atomic energy control instruments, airplane or spaceship instruments, transportation instruments, traffic signal instruments, combustion control instruments, medical instruments, all types of safety devices, etc.. Unintended Usage of TOSHIBA products listed in this document shall be made at the customer's own risk.
- The products described in this document are subject to the foreign exchange and foreign trade laws.
- The information contained herein is presented only as a guide for the applications of our products. No responsibility is assumed by TOSHIBA CORPORATION for any infringements of intellectual property or other rights of the third parties which may result from its use. No license is granted by implication or otherwise under any intellectual property or other rights of TOSHIBA CORPORATION or others.
- The information contained herein is subject to change without notice.